

A3 (8Y) Sportback 03/20➔

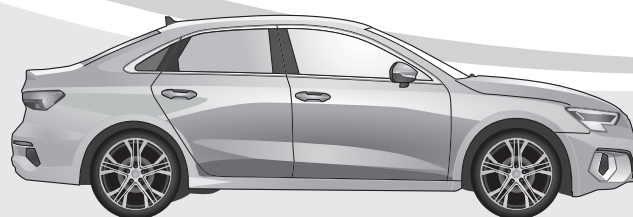

A3 (8Y) Limousine 04/20➔
A3 (8Y) Saloon 04/20➔

D

Einbauanleitung
Elektro-Einbausatz für Anhängerkupplung / 13-polig / 12 Volt / ISO 11446

GB

Fitting instructions
Electric wiring kit for towbars / 13-pin / 12 Volt / ISO 11446

F

Instructions de montage
Faisceau pour attelage / 13 broches / 12 Volt / ISO 11446

I

Istruzione di montaggio
Cablaggio elettrico per ganci di traino / 13 poli / 12 Volt / ISO 11446

E

Instrucciones de montaje
Kits eléctricos para enganches de remolques / 13 pins / 12 Volt / ISO 11446

NL

Montagehandleiding
Elektro-inbouwset voor aanhangerkoppeling / 13-polig / 12 Volt / ISO 11446



WICHTIG!

D

Vor Montagebeginn:

- Die aktuellen Herstellervorgaben beachten!
- Die Einbauanleitung komplett durchlesen und zwingend beachten!
- Dieses Produkt ist nur für linksgelenkte (LHD) Fahrzeuge geeignet!
- Bei Fremdverwendung oder Veränderung des Produktes erlischt jeglicher Anspruch auf Einbauunterstützung und Gewährleistung!

Änderungen bezüglich Konstruktion, Ausstattung, Farbe sowie Irrtum vorbehalten. Alle Angaben und Abbildungen sind unverbindlich. Der in Deutsch gehaltene Text in dieser Einbau-Anleitung ist bindend!

Für technische bzw. elektronische Änderungen, sowie Softwareupdates, welche nach erstmaliger Inbetriebnahme des Elektrosatzes vom Fahrzeughersteller durchgeführt werden und beispielsweise zu Fehlfunktionen der Anhängersteckdose oder deren Peripherie führen, übernehmen wir keinerlei Gewährleistung!

Je nach Art des im E-Satz verwendeten Anhängermoduls ist eine Interaktion mit dem Fahrzeugbordnetz nur eingeschränkt oder gar nicht möglich. Mit den spezifischen Diagnosesystemen der Fahrzeughersteller kann nicht auf modulinterne Fehlerspeicher zugegriffen werden.

Fehlerprotokolle in Bezug auf Anhängerbetrieb, die während eines Prüfprozesses mit den Diagnosesystemen der Fahrzeughersteller generiert werden, sind mitunter auf eine nicht ordnungsgemäße Freischaltung für Anhängerbetrieb zurückzuführen.

Wir empfehlen

- die Auswertung der fahrzeugseitigen Fehlerspeicher sowie ggf. die Instandsetzung aller gelisteten Defekte vor Beginn aller Montagearbeiten!
- das Anhängermodul ggf. vom Leitungssatz zu trennen und den Diagnoseprozess noch einmal zu starten!
- die Fehlersuche bei Funktionsproblemen auf max. 0,5 Stunden zu begrenzen und sich danach an unsere Hotline zu wenden!



HOTLINE +49 5246 921019
support@jaeger-automotive.de



IMPORTANT!

GB

Before starting the installation:

- Pay attention to the latest manufacturer's specifications!
- Read the complete installation instructions and follow these at all costs!
- This product is only designed for left-hand drive (LHD) vehicles!
- If the product is used for a different purpose or modified, any entitlement to support during the installation and the warranty will be forfeited!

Subject to changes with respect to design, equipment, colour and error. All of the data and illustrations are without obligation. The German text in these installation instructions is binding!

We can assume no warranty or guarantee for technical and electrical modifications or software updates carried out by the vehicle manufacturer following the initial commissioning of the electric kit and which, for example, may lead to malfunctions in the trailer socket or its peripheral equipment!

Depending on the type of trailer module used in the electric kit, interaction with the vehicle's electrical system may be limited or even impossible. The error memory inside the module cannot be accessed with the specific diagnostic system of the vehicle manufacturer.

Error logs relating to the trailer mode that are generated during a test process with the vehicle manufacturer's diagnostic system are sometimes due to an incorrect activation for the trailer mode.

We recommend

- an analysis of the vehicle's error memory and possibly the repair of all listed faults before the start of the installation!
- possibly disconnecting the trailer module from the lead set and re-starting the diagnosis process!
- limiting troubleshooting in the event of malfunctions to a max. of 0.5 hours and then contacting our hotline!



HOTLINE +49 5246 921019
support@jaeger-automotive.de



IMPORTANT!

F

Avant de commencer le montage:

- Respecter les consignes actuelles du constructeur!
- Lire la notice d'installation en entier et en tenir rigoureusement compte!
- Ce produit convient uniquement pour les véhicules avec conduite à gauche (LHD)!
- Tout autre usage ou modification du produit entraîne l'annulation de toute prétention à une assistance pour le montage ainsi qu'à la garantie!

Sous réserve de modifications sur le plan de la construction, de l'équipement, de la couleur ainsi que d'erreurs. Toutes les informations et illustrations sont fournies sans engagement. Le texte en allemand dans cette notice d'installation fait foi!

Nous déclinons toute responsabilité pour les modifications techniques ou électroniques, ainsi que pour les mises à jour logicielles réalisées après la mise en service initiale du kit électronique du constructeur du véhicule et pouvant provoquer par exemple des dysfonctionnements de la prise de courant de la remorque ou de sa périphérie!

Suivant le type de module de remorque utilisé dans le kit électronique, une interaction avec le réseau de bord du véhicule n'est pas possible ou ne l'est que dans certaines limites. Il est impossible d'accéder aux mémoires d'erreurs internes avec les systèmes de diagnostic spécifiques des constructeurs de véhicules.

Les procès-verbaux d'erreurs concernant le fonctionnement de la remorque qui ont été générés durant un processus de contrôle avec les systèmes de diagnostic des constructeurs de véhicules sont parfois attribuables à une activation non conforme pour le fonctionnement de la remorque.

Nous recommandons

- d'analyser les mémoires d'erreurs du véhicule ainsi qu'éventuellement de réparer toutes les défaillances mentionnées avant le commencement de tous les travaux de montage!
- de séparer le module remorque le cas échéant du jeu de câbles et de remettre en marche encore une fois le processus de diagnostic!
- de limiter la recherche d'erreurs à 0,5 h maximum en cas de problèmes de fonctionnement et de s'adresser ensuite à notre hotline!



HOTLINE +49 5246 921019
support@jaeger-automotive.de



IMPORTANTE!



Prima dell'inizio del montaggio:

- Si prega di osservare tassativamente le indicazioni attuali del costruttore!
- Leggere integralmente e attenersi alle istruzioni di montaggio!
- Questo prodotto è adatto solo a veicoli con la guida a sinistra (LHD)!
- In caso di utilizzo scorretto o modifica del prodotto, decade ogni diritto di supporto al montaggio e di garanzia!

Con riserva di modifiche strutturali, di dotazione, colore ed errori. Tutti i dati e le figure non sono vincolanti. Il testo in tedesco in queste istruzioni di montaggio è vincolante!

Non concediamo alcuna garanzia per modifiche tecniche o elettroniche, aggiornamenti software che dopo la prima messa in funzione del gruppo elettronico vengono effettuate dal costruttore del veicolo e, ad esempio, possono causare malfunzionamenti della presa del rimorchio o delle sue periferiche!

A seconda del tipo di modulo rimorchio utilizzato nel gruppo elettronico, l'interazione con la rete di bordo del veicolo è possibile solo parzialmente o non è affatto possibile. Con i sistemi di diagnosi specifici dei costruttori di veicoli, non è possibile accedere alla memoria errori interna al modulo.

I protocolli di errore riferiti al funzionamento con rimorchio, generati durante un processo di collaudo con i sistemi di diagnosi dei costruttori di veicoli, sono da ricondurre, tra l'altro, a un'attivazione non corretta per funzionamento con rimorchio.

Consigliamo

- di effettuare assolutamente l'analisi della memoria errori sul veicolo ed eventualmente la riparazione di tutti i difetti riscontrati, prima di iniziare qualsiasi lavoro di montaggio;
- di scollegare eventualmente il modulo rimorchio dalla serie di cavi e di avviare nuovamente il processo di diagnosi;
- di limitare la ricerca errori in caso di problemi di funzionamento a max. 0,5 ore, quindi di rivolgersi al nostro numero verde.



HOTLINE +49 5246 921019
support@jaeger-automotive.de



¡IMPORTANTE!



Antes de comenzar el montaje:

- ¡Observar las especificaciones actuales del fabricante!
- ¡Leer las instrucciones de montaje por completo y seguirlas sin falta!
- ¡Este producto solo es apto para vehículos con volante a la izquierda (LHD)!
- ¡El uso fuera de este ámbito o la modificación del producto supone la extinción de cualquier derecho de asistencia técnica para el montaje y garantía!

Queda reservado el derecho a realizar modificaciones constructivas, de equipamiento y color y de posibles errores. Todos los datos e ilustraciones se entienden sin compromiso. ¡La versión vinculante de estas instrucciones de montaje es la original en lengua alemana!

¡No asumiremos garantía alguna por modificaciones técnicas y/o electrónicas o actualizaciones de software que se lleven a cabo después de la primera puesta en servicio del kit eléctrico por parte del fabricante del vehículo y que puedan dar lugar, por ejemplo, a fallos de funcionamiento de la base eléctrica para el remolque o los periféricos!

En función del tipo de módulo para remolques CFC utilizado en el kit eléctrico no se podrá interactuar con el sistema eléctrico de a bordo o solo de forma limitada. Los sistemas de diagnóstico específicos de los fabricantes de vehículos no permiten el acceso a las memorias de fallos internas del módulo.

Los protocolos de fallos referidos al servicio con remolque, que se generen con sistemas de diagnóstico de los fabricantes de vehículos durante un proceso de inspección, a veces son el resultado de un desbloqueo incorrecto para el servicio con remolque.

Recomendamos:

- ¡evaluar las memorias de fallos del vehículo y eliminar, en caso dado, todos los defectos enumerados antes de comenzar los trabajos de montaje!
- ¡separar el módulo para remolques del juego de cables en caso dado y volver a iniciar el proceso de diagnóstico!
- ¡limitar la búsqueda de fallos en caso de problemas de funcionamiento a un máximo de 0,5 horas y acudir entonces a nuestra línea de atención!



HOTLINE +49 5246 921019
support@jaeger-automotive.de



BELANGRIJK!



Voordat u begint te monteren:

- Raadpleegt u eerst de actuele richtlijnen van de producent!
- Leest u de instructies voor de installatie helemaal door en volg de aanwijzingen nauwgezet op!
- Dit product is alleen geschikt voor voertuigen met een stuur aan de linkerkant!
- Wanneer het product wordt gewijzigd of niet op correcte wijze wordt gebruikt, vervallen alle garanties en alle rechten op ondersteuning bij de inbouw.

Aan deze informatie en afbeeldingen kunnen geen rechten worden ontleend. Wijzigingen voorbehouden ten aanzien van constructie, uitrusting, kleur en/of eventuele misrekening/vergingssing. De Duitstalige tekst van deze gebruiksaanwijzing is bindend!

Wij dragen geen enkele aansprakelijkheid voor technische en/of elektronische wijzigingen alsmede software-updates die worden verricht na de eerste inbedrijfstelling van de elektrische set door de autofabrikant en die bijvoorbeeld leiden tot fouten in het functioneren van de aanhangerstekkerdoos en/of de randapparatuur!

Afhankelijk van de soort aanhangermodule die in de elektrische set wordt gebruikt, kan de interactie met het voertuignetwerk beperkt of zelfs onmogelijk zijn. Met de specifieke diagnostische systemen van de autofabrikant is geen toegang mogelijk tot foutenlogboeken die zich in de module zelf bevinden.

Foutrapportages ten aanzien van de werking van de aanhanger, die kunnen worden gegenereerd tijdens testprocedures door het diagnostische systeem van de autofabrikant, zijn soms te herleiden tot een incorrecte aansluiting en/of activering van het aanhangersysteem.

Wij raden u aan

- de foutrapportages van uw voertuig te inspecteren, en de nodige reparaties te verrichten, voor aanvang van elk montagewerk!
- uw aanhangermodule indien nodig los te koppelen van de kabelset, waarna u de diagnoseprocedure opnieuw opstart!
- in geval van functionele problemen niet langer dan een half uur te zoeken naar een fout, maar contact op te nemen met onze hotline!



HOTLINE +49 5246 921019
support@jaeger-automotive.de

Werkzeuge - Tools - Outils - Utensile - Herramientas - Werktuigen

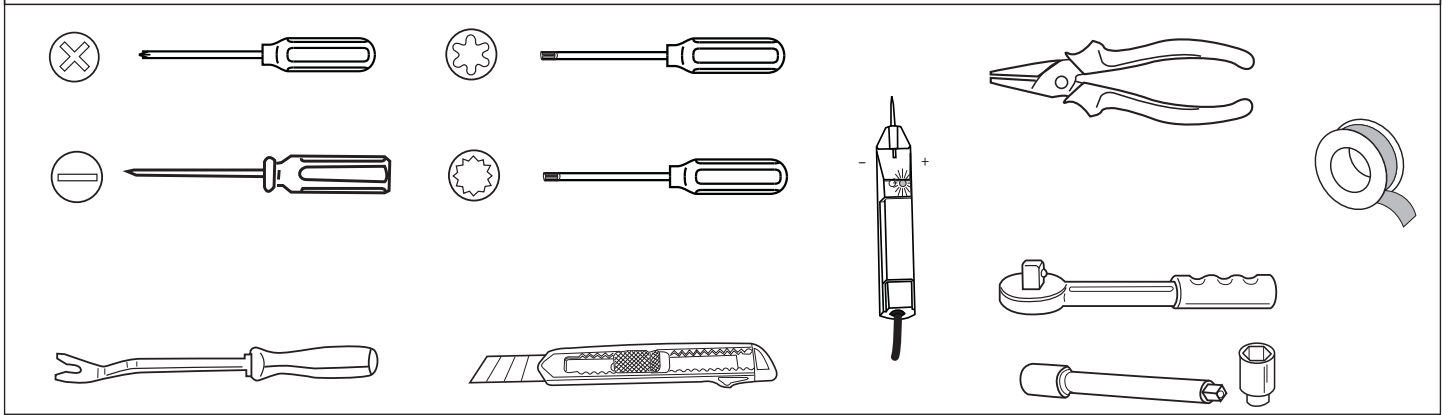

BK
10-pol

BK/VT
6-pol

Mit
Anhänger-Vorbereitung!

Ohne
Anhänger-Vorbereitung!

ACHTUNG!	ATTENTION!	ATTENTION!	ATTENZIONE!	¡ATENCIÓN!	ATTENTIE!	
(D)	(GB)	(F)	(I)	(E)	(NL)	
Die Kühlerleistung des Fahrzeuges muß bei Nachrüstung einer Anhängerkupplung möglicherweise erhöht werden! Bitte unbedingt Herstellerangaben beachten!!	The vehicle's cooling capacity may have to be increased when retrofitting a trailer coupling! You must observe the manufacturer's instructions!!	Il peut s'avérer nécessaire d'augmenter la puissance du radiateur du véhicule lorsque celui est équipé ultérieurement d'un attelage remorque! Respecter impérativement les instructions du constructeur!!	La capacità di raffreddamento del veicolo, quando si applica un gancio di traino, si deve possibilmente aumentare! Si prega di osservare tassativamente le indicazioni del produttore!!	¡Es posible que haya que aumentar la capacidad del radiador en caso de reequipar un acoplamiento de remolque! ¡Rogamos tener en cuenta las instrucciones de fabricante sin falta!	Het koelvermogen van het voertuig moet mogelijk worden verhoogd als achteraf een aanhangerkoppeling wordt aangebracht! Absoluut de fabrieksopgaven in acht nemen a.u.b.!!	

ACHTUNG!	ATTENTION!	ATTENTION!	ATTENZIONE!	¡ATENCIÓN!	ATTENTIE!	
Um Störungen und Schäden am Bordnetz zu vermeiden, muß die Massepolklemme unbedingt vor Beginn aller Arbeiten von der Fahrzeugbatterie getrennt werden!	In order to avoid malfunctions and damage to the vehicle's electrical system the earth terminal must be disconnected from the vehicle's battery before starting work!	Afin d'éviter tout dysfonctionnement ou endommagement du circuit de bord, il est indispensable de débrancher la pince de masse de la batterie du véhicule avant le début de toute opération!	Per evitare disturbi e danni alla rete di distribuzione elettrica, l'espansione polare a massa deve essere assolutamente scollegata dalla batteria del veicolo prima dell'inizio dei lavori!	¡Para evitar fallos y defectos en el sistema eléctrico de a bordo es imprescindible separar al terminal de puesta a tierra de la batería del vehículo antes de realizar cualquier trabajo!	Om storingen en schade aan de elektrische bedrading te vermijden moet de massapoolklem absoluut vóór aanvang van alle werkzaamheden worden losgekoppeld van de voertuigaccu!	
Insbesondere bei Arbeiten und Anschlüssen am CAN-Datenbus kann bei nicht abgeklemmter Batterie sowohl das Anhängermodul als auch das fahrerseitige Bordnetzsteuergerät beschädigt werden!	Both the trailer module and the vehicle's control unit for the electrical system can be damaged during work on the CAN data bus connections if the battery is not disconnected!	En particulier s'il s'agit de travaux et de branchements effectués sur le bus de données CAN, si la batterie n'est pas débranchée, le module remorque aussi bien que le dispositif de commande de circuit de bord du véhicule risquent d'être endommagés!	In particolare durante i lavori e gli allacciamenti al bus di dati CAN, se la batteria non è scollegata si possono danneggiare sia la centralina rimorchio, sia la centralina della rete di distribuzione elettrica del veicolo!	¡Particularmente al realizar trabajos y conexiones al bus de datos CAN puede estropearse tanto el módulo para remolques como el regulador del sistema eléctrico de a bordo del vehículo si no se ha desconectado la batería!	Vooral bij werkzaamheden aan en aansluitingen op de CAN-databus kan zowel de aanhangermodule als de voertuigzijdige regeleenheid voor de elektrische installatie beschadigd worden, als de accu niet ontkoppeld is!	
Bitte Herstellervorschriften beim Ab- und Anklemmen der Fahrzeugbatterie beachten!	Please pay attention to the manufacturer's instructions when disconnecting and reconnecting the vehicle's battery!	Veuillez respecter les directives du fabricant lors du branchement et du débranchement de la batterie du véhicule!	Attenersi alle indicazioni del costruttore per scollegare e ricollegare la batteria del veicolo!	¡Rogamos observar las instrucciones del fabricante al conectar y desconectar la batería del vehículo!	Fabrieksvoorschriften bij het vasten loskoppelen van de voertuigaccu in acht nemen a.u.b.!	

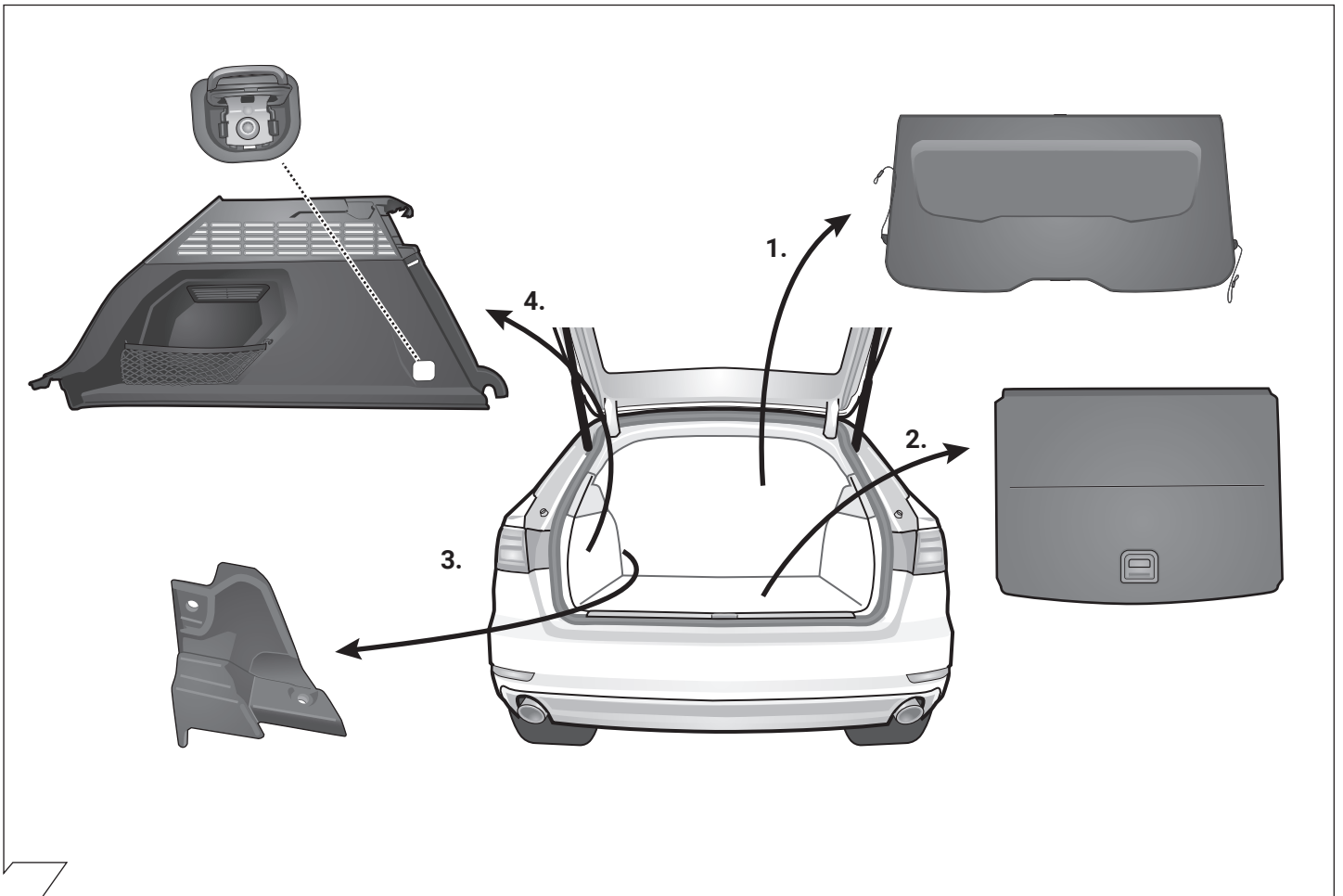

2

Für Fahrzeuge ohne Anhängervorbereitung!

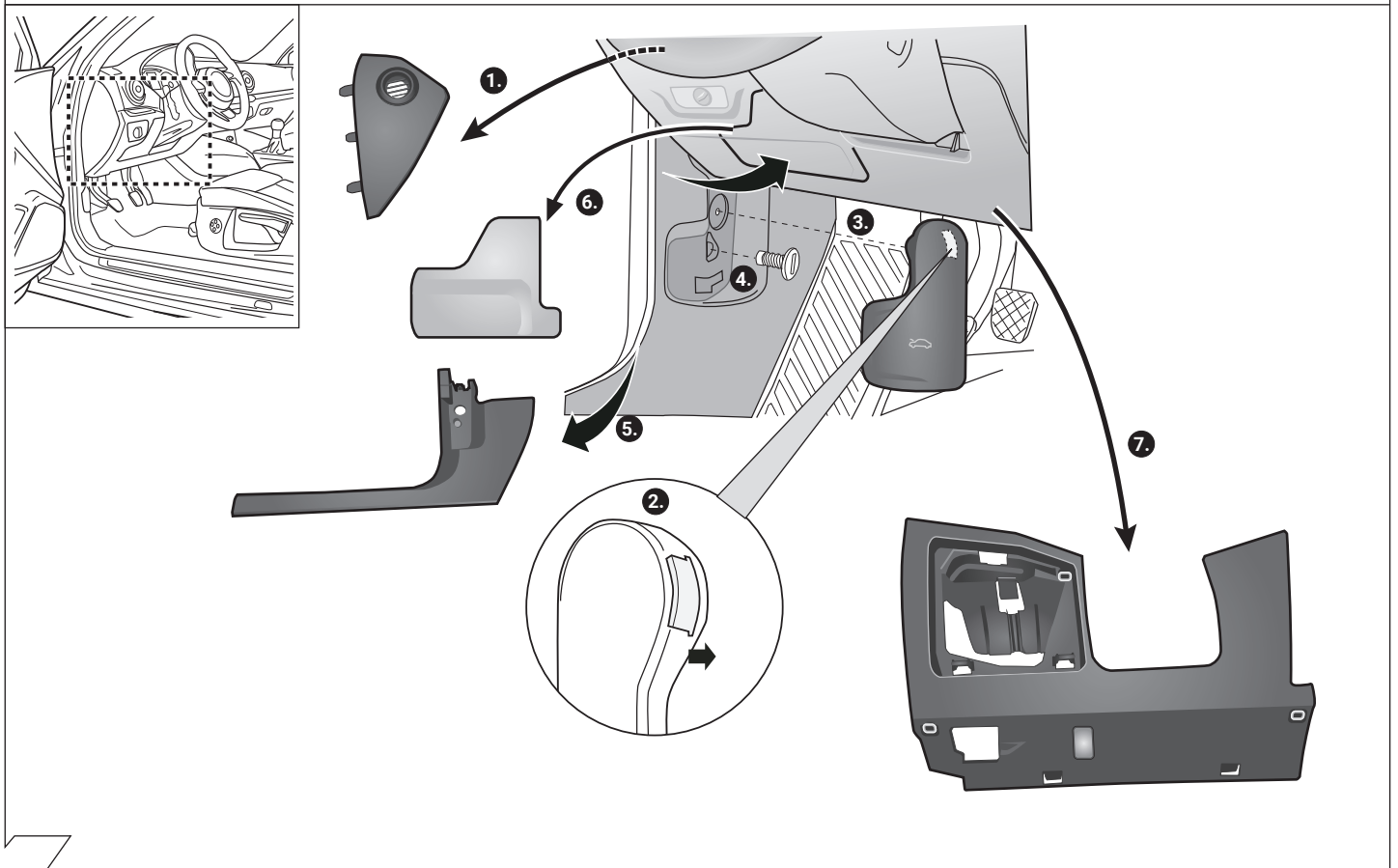

3

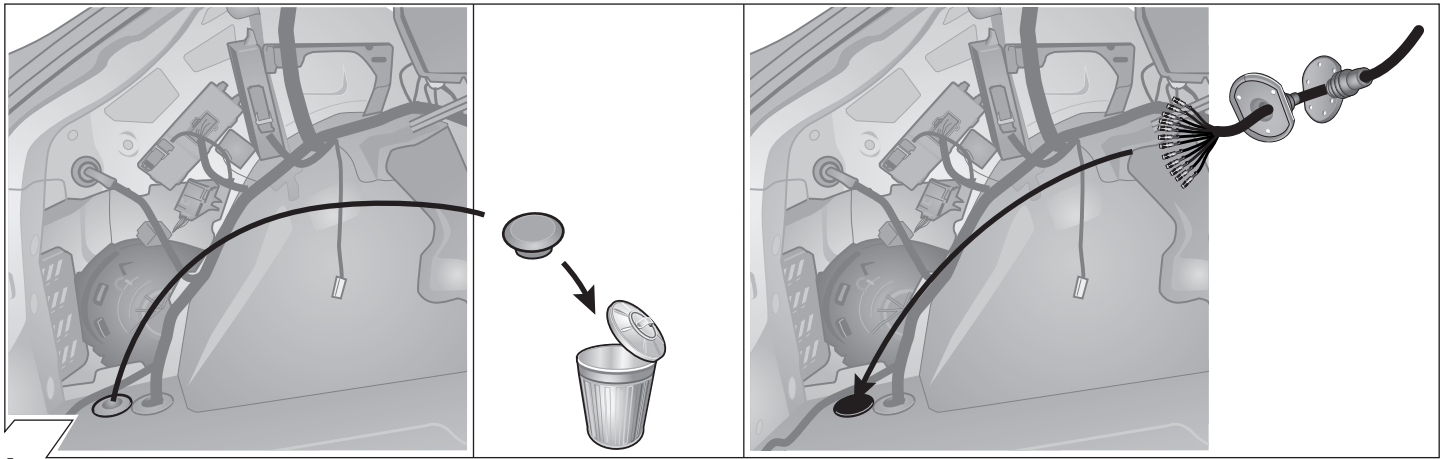

4

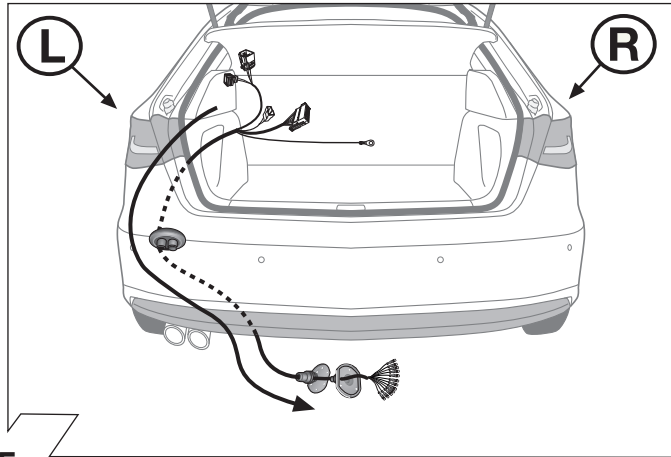

5

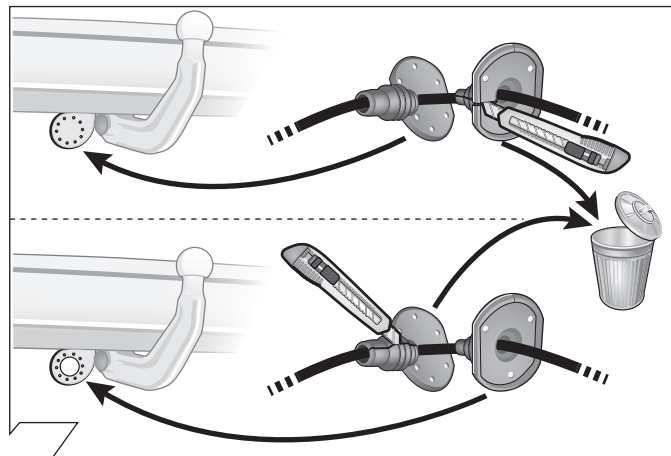

6

ISO 11446	Belegung der Steckdose / Maximale Ausgangsleistung Socket configuration / Maximum power output Correspondance des contacts de la prise / Puissance de sortie maximale Abbinamento della presa / Uscita di alimentazione massima Indeling van de stekkerdoos / maximaal uitgangsvermogen		
	1/L	BK/WT	21W
	2	WT	42W
	3/31	BR	XXXX
	4/R	BK/GN	21W
	5/58-R	GY/RD	52W
	6/54	BK/RD	63W
	7/58-L	GY/BK	52W
	8	BL/RD	42W
	9	RD	240W
	10	YL	180W
	11	YL/BR	XXXX
	12	XXXX	XXXX
	13	RD/BR	XXXX

7

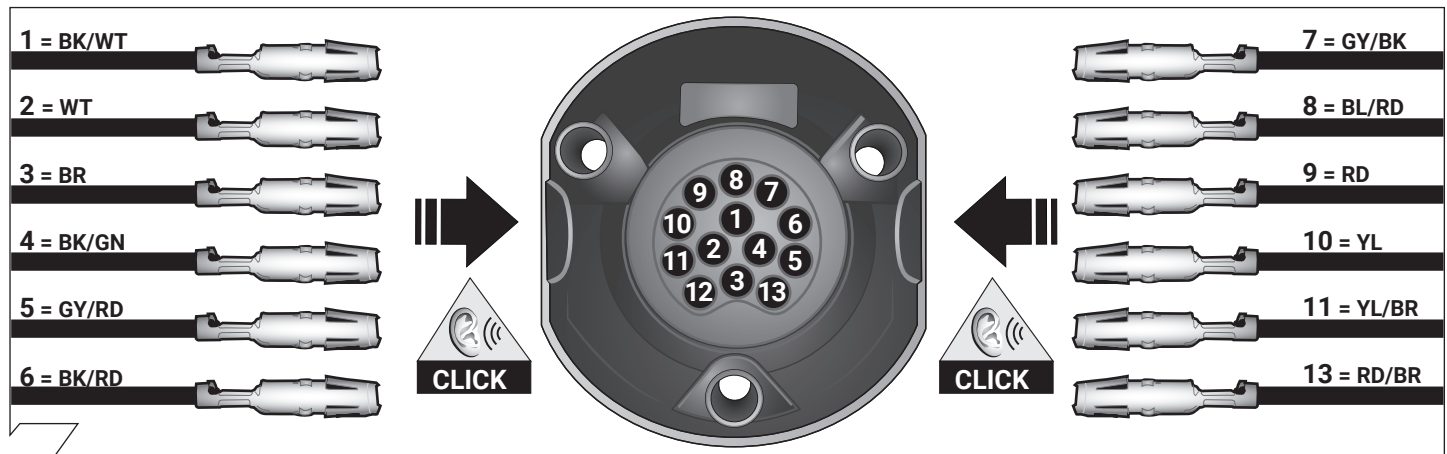

8

	GB	D	E	F	I	P	NL	DK	N	S	FIN	CZ	H	PL
BK	Black	Schwarz	Negro	Noir	Nero	Preto	Zwart	Sort	Svart	Svart	Musta	Černá	Fekete	Czarny
RD	Red	Rot	Rojo	Rouge	Rosso	Vermelho	Rood	Rød	Rød	Röd	Punainen	Červená	Piros	Czerwony
GN	Green	Grün	Verde	Vert	Verde	Verde	Groen	Grøn	Grønt	Grön	Vihreä	Zelená	Zöld	Zielony
OR	Orange	Orange	Naranja	Orange	Arancione	Laranja	Oranje	Orange	Orange	Orange	Oranssi	Oranzová	Narancs	Pomarańczowy
VT	Violet	Violett	Violeta	Violet	Viola	Violeta	Violet	Violet	Fiolett	Violett	Violetti	Fialová	Ibolya	Fioletowy
PK	Pink	Pink	Pink	Rose	Rosa	Cor-de-Rosa	Paars	Pink	Pink	Rosa	Pinkki	Růžová	Rózsaszín	Różowy
BL	Blue	Blau	Azul	Bleu	Blu	Azul	Blauw	Blå	Blått	Blå	Sininen	Modrá	Kék	Niebieski
YL	Yellow	Gelb	Amarillo	Jaune	Giallo	Amarelo	Geel	Gul	Gult	Gul	Keltainen	Zlutá	Sárga	Żółty
WT	White	Weiss	Blanco	Blanc	Bianco	Branco	Wit	Hvid	Hvitt	Vit	Valkoinen	Bílá	Fehér	Biały
BR	Brown	Braun	Marrón	Brun	Marrone	Marrom	Bruin	Brun	Brunt	Brun	Ruskea	Hnědá	Barna	Brazowy
GY	Grey	Grau	Gris	Gris	Grigio	Cinzeno	Grijs	Grå	Grått	Grå	Harmaa	Sedá	Szürke	Szary

9

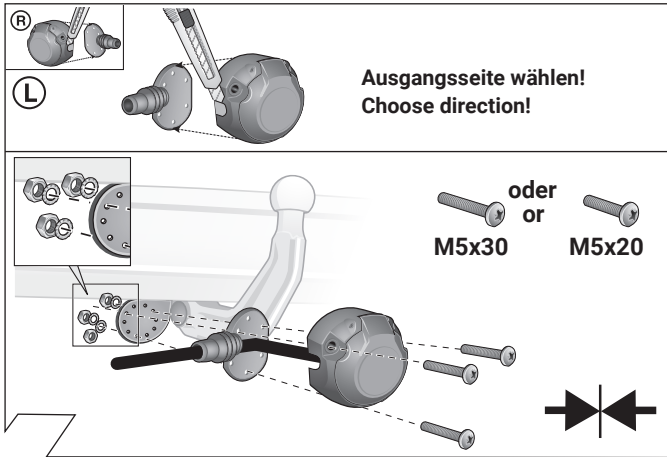

10

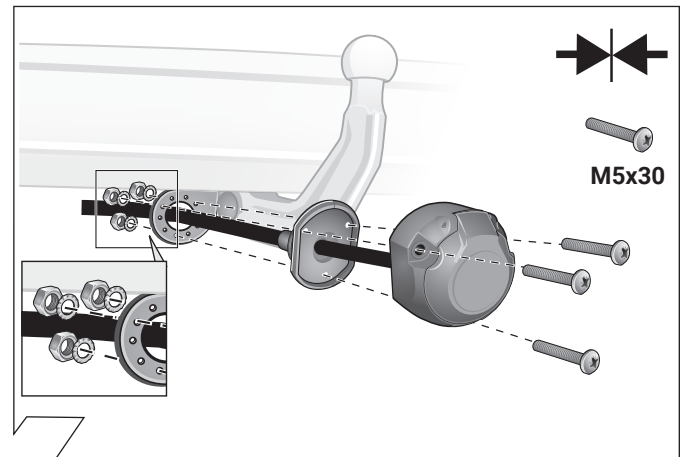

11

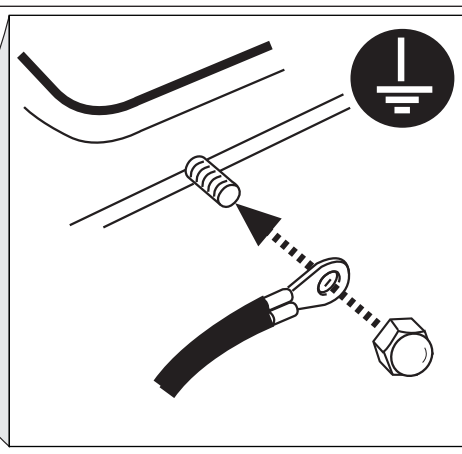
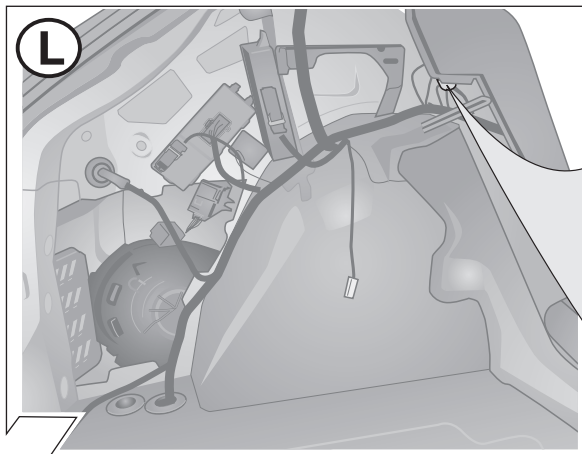

12

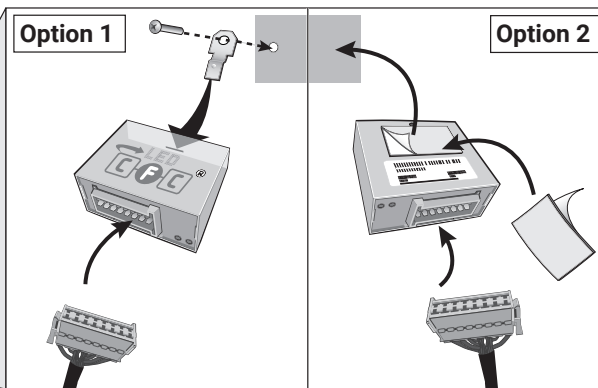
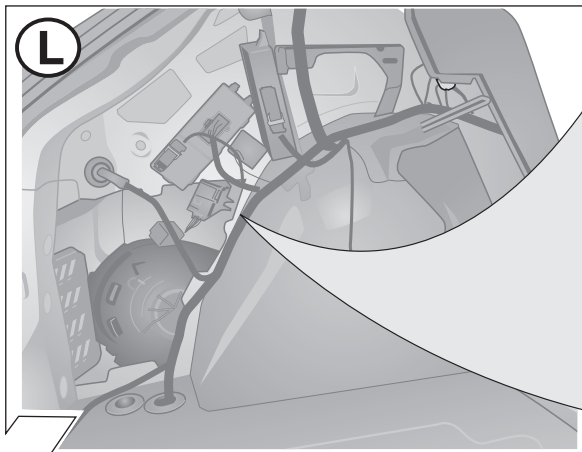

13

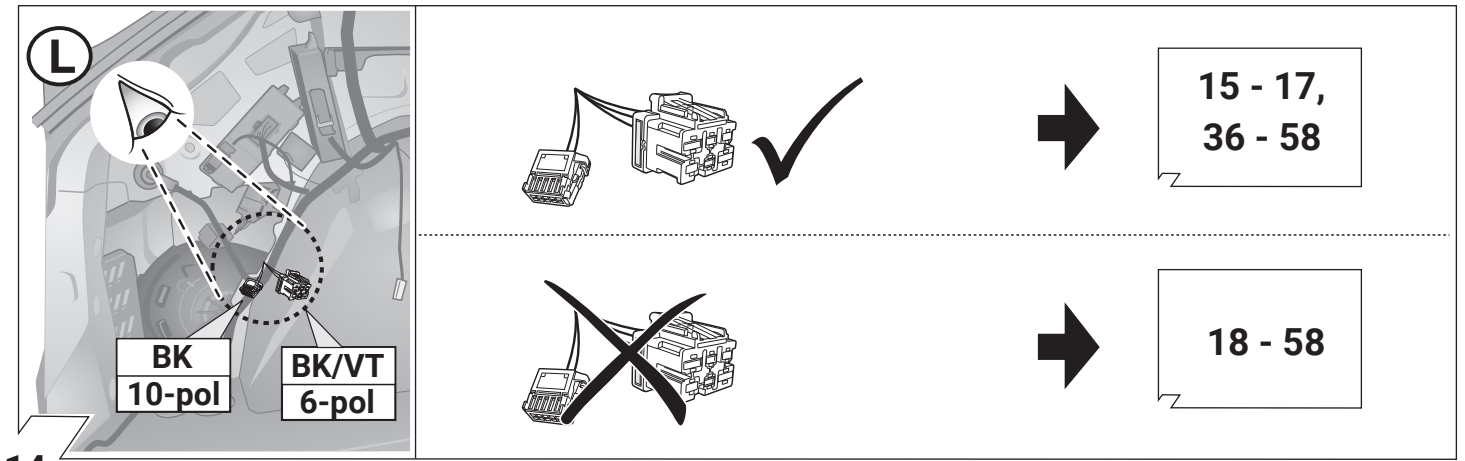

14

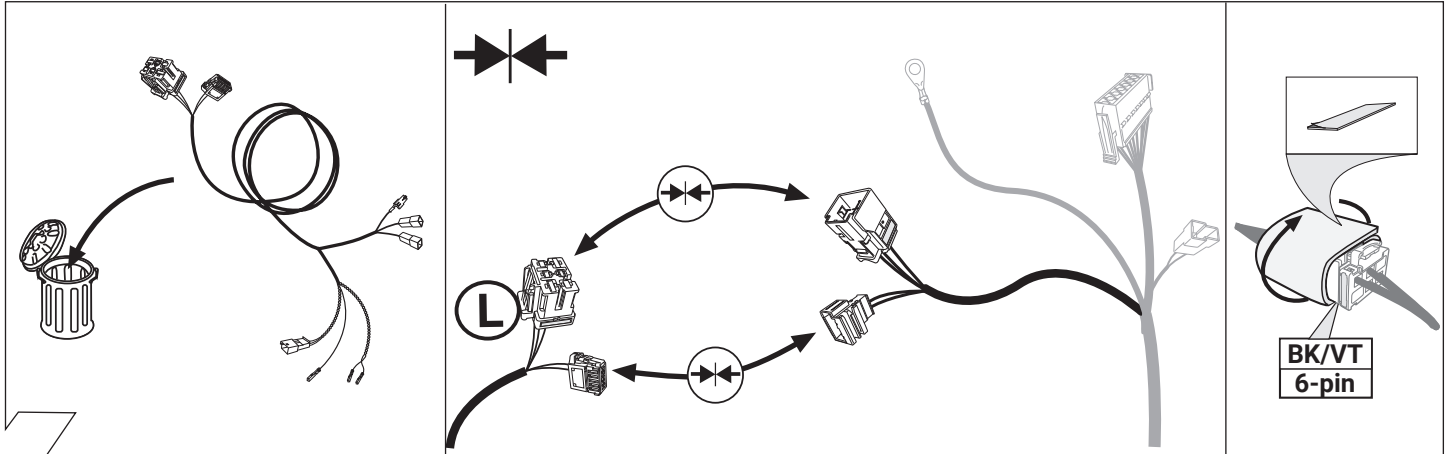

15

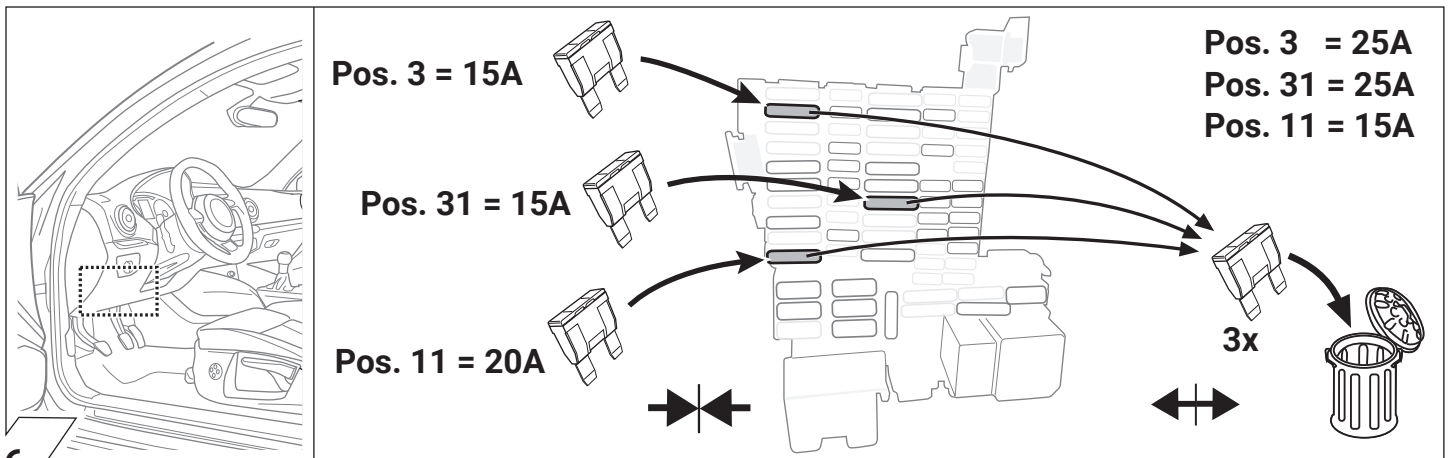

16

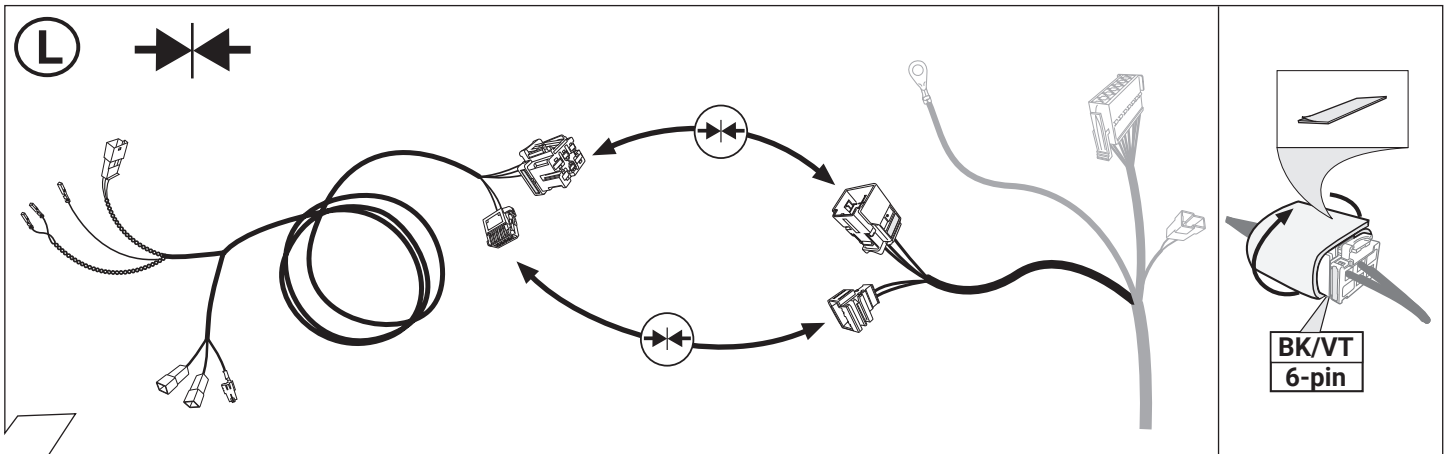

17

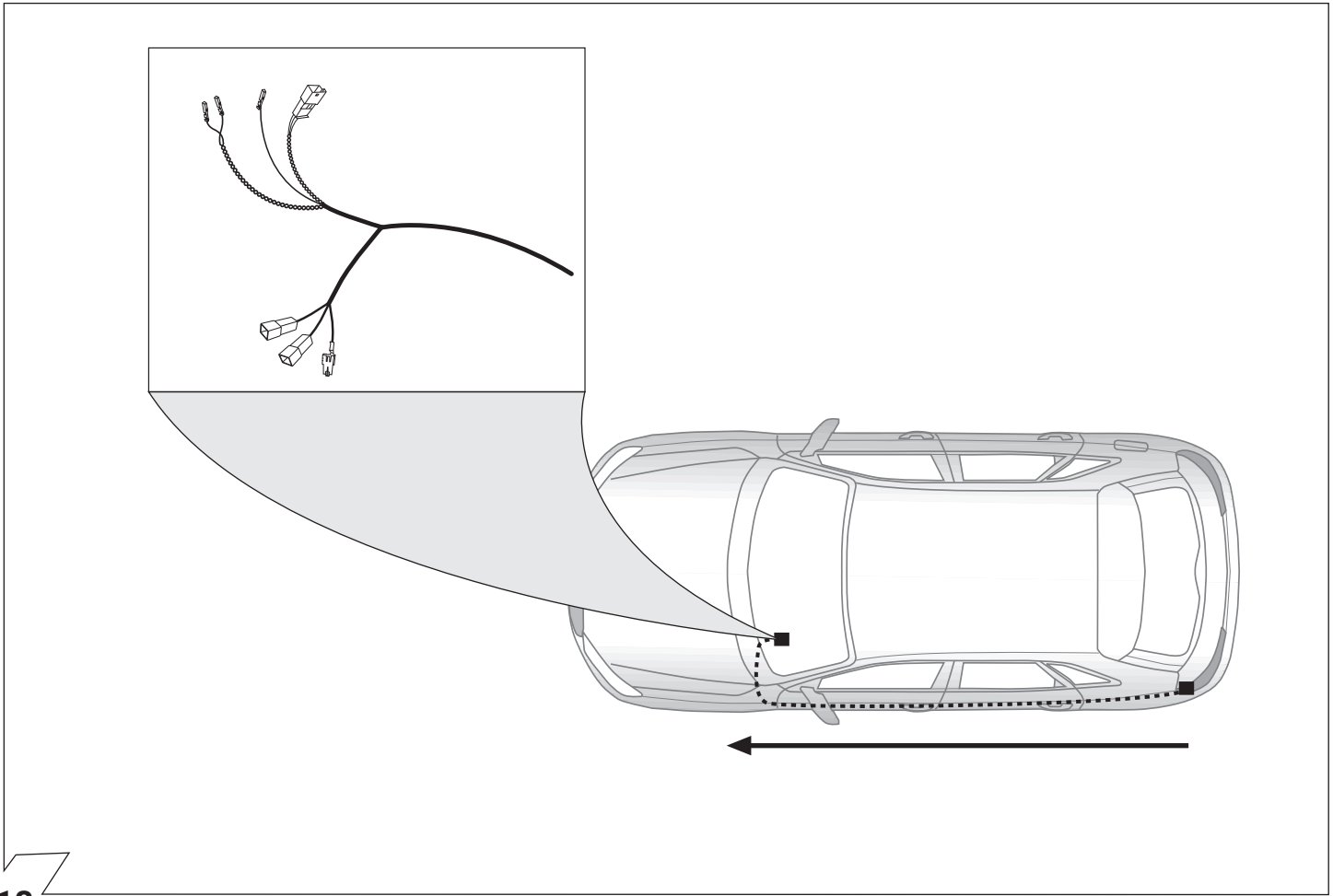

18

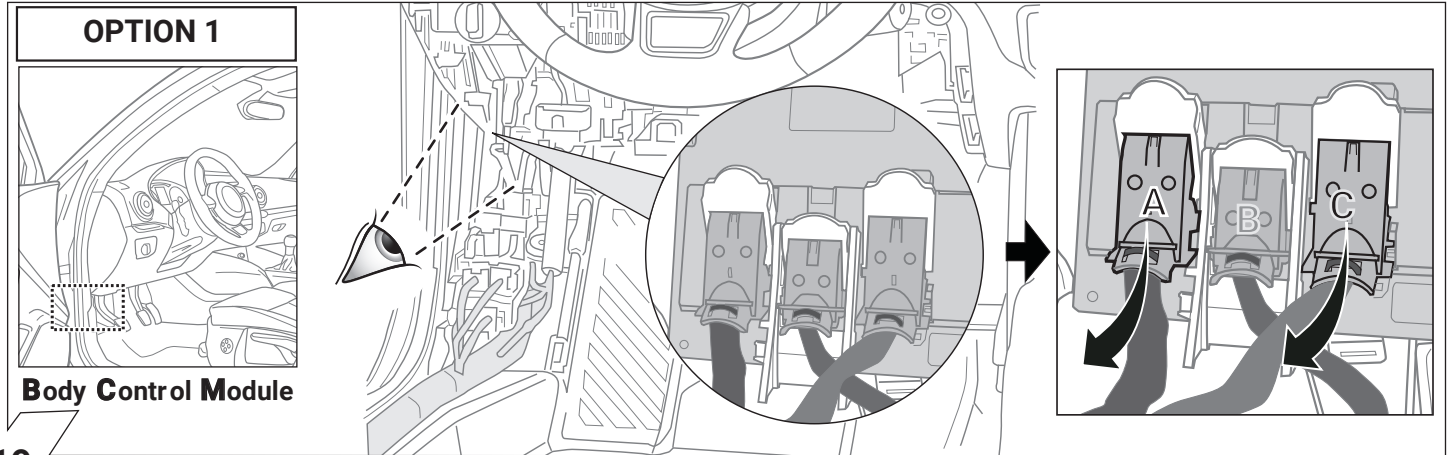

19

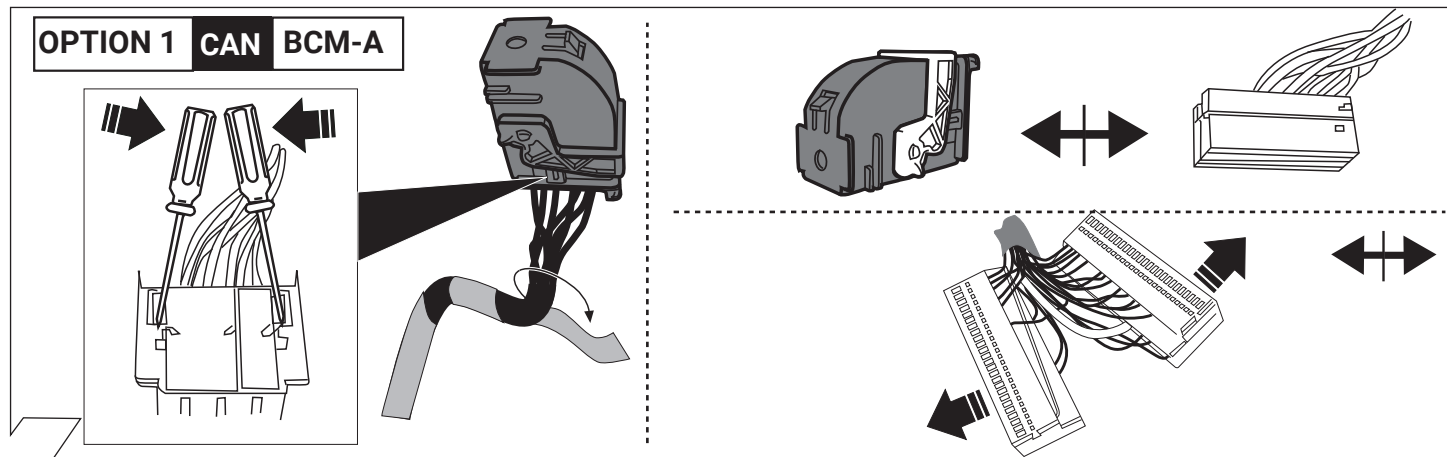

20

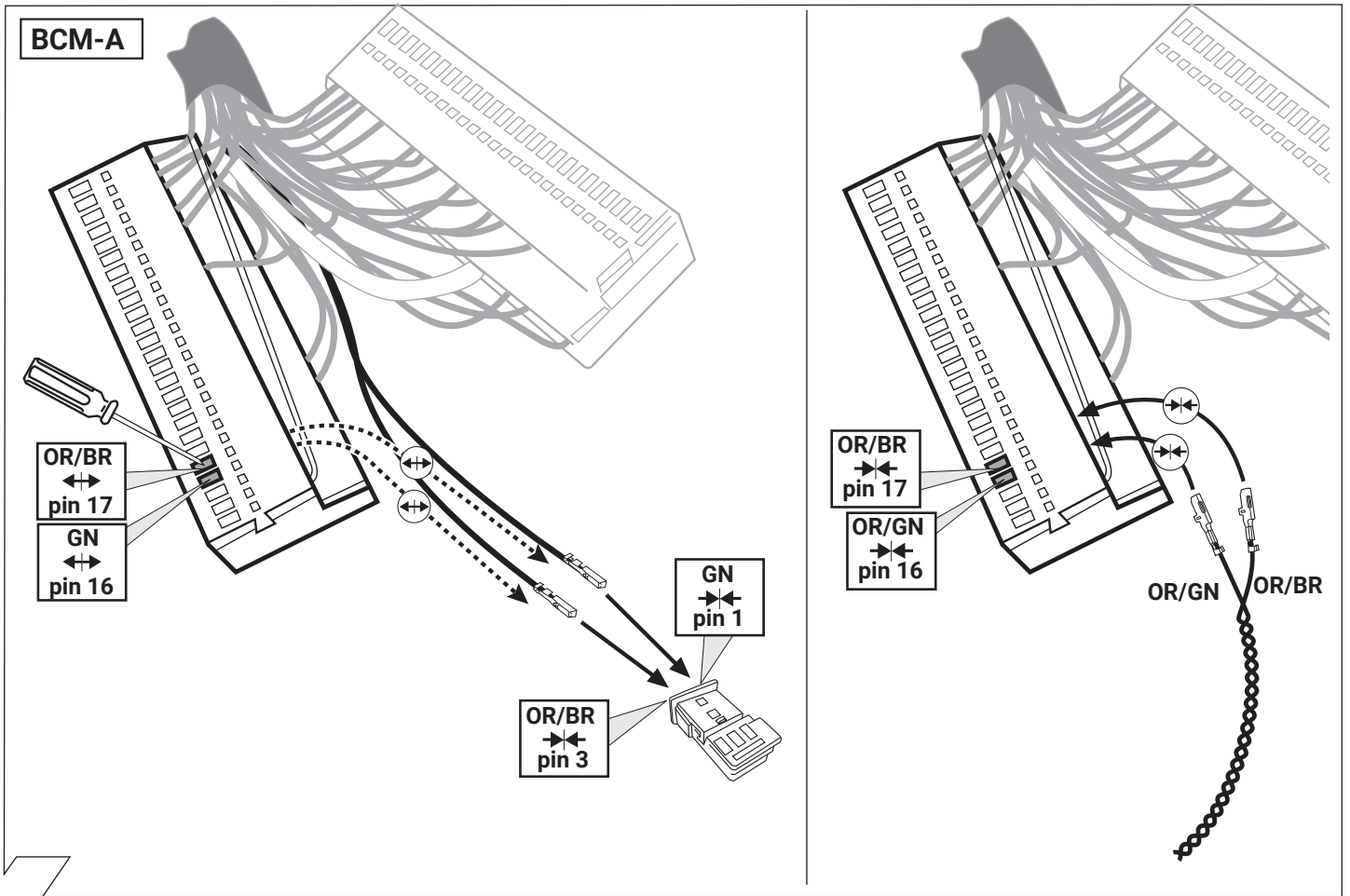

21

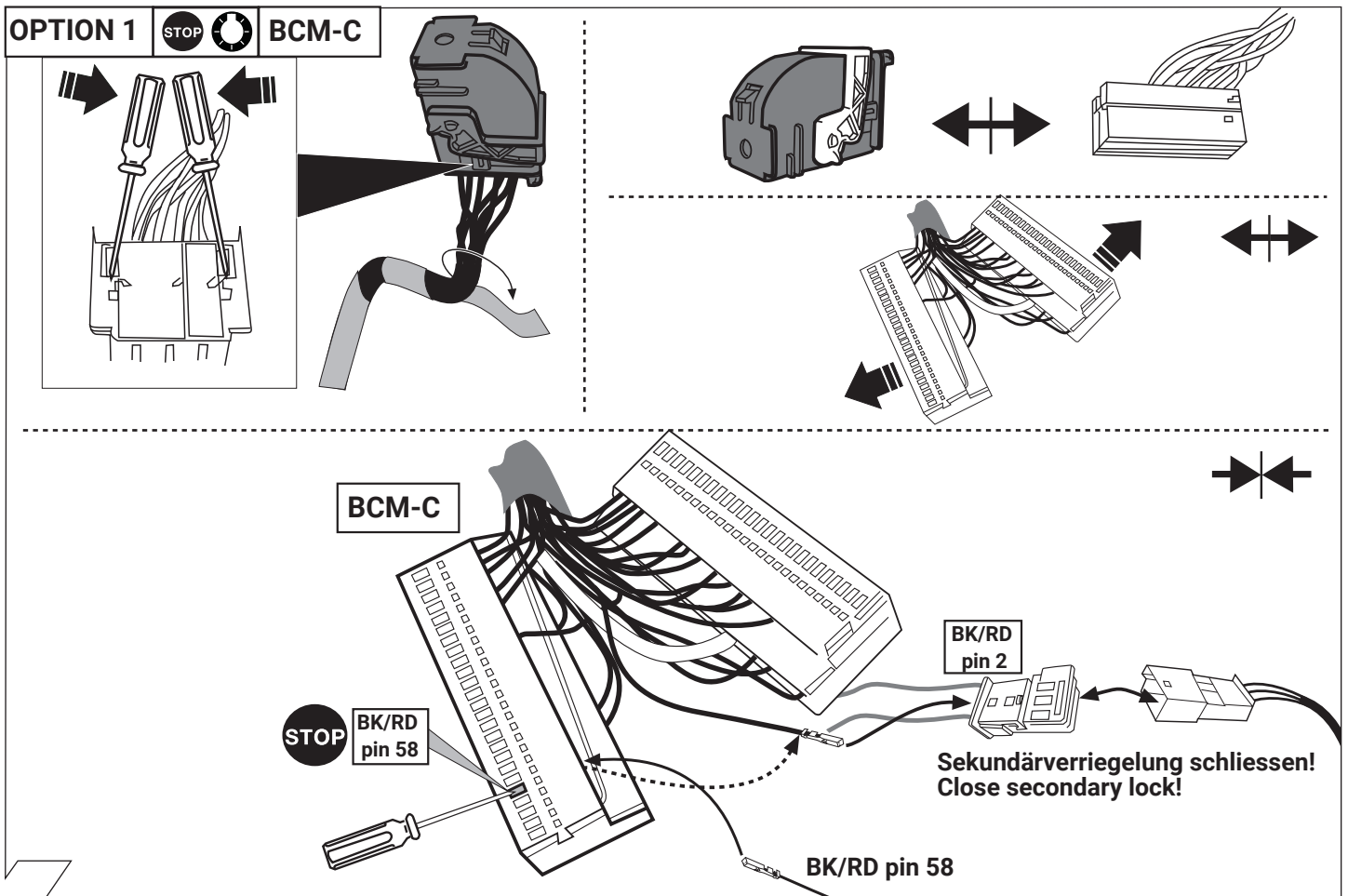

22

OPTION 2

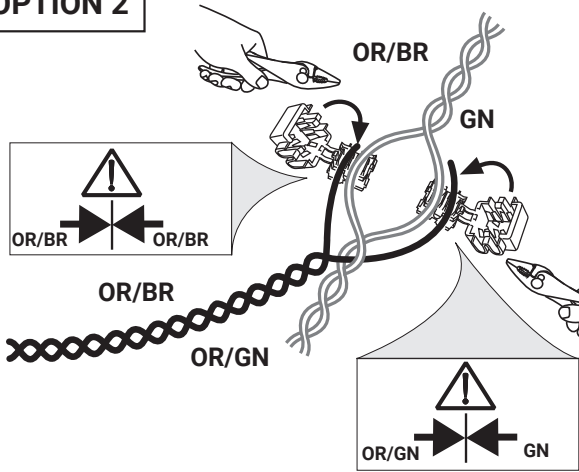

Bordnetzsteuergerät
Steckgehäuse A
Network control unit
connector A

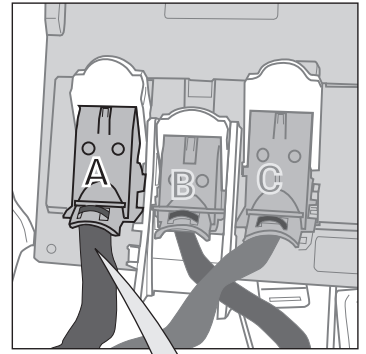
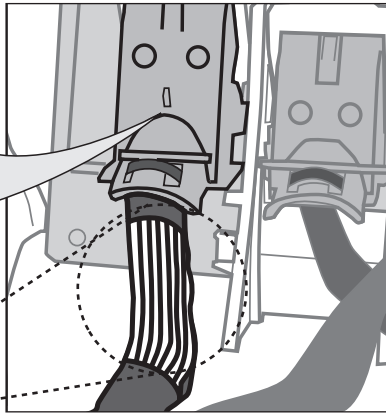
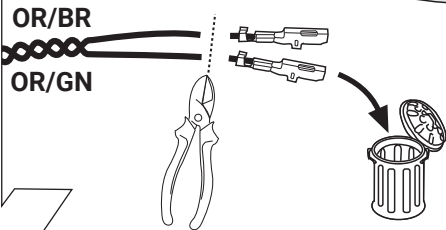

23

OPTION 2

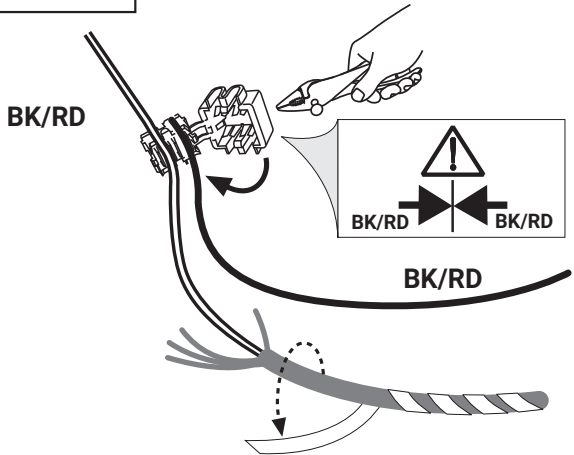

Bordnetzsteuergerät
Steckgehäuse C
Network control unit
connector C

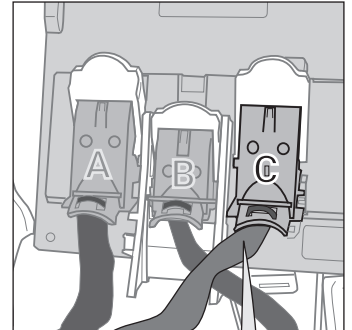
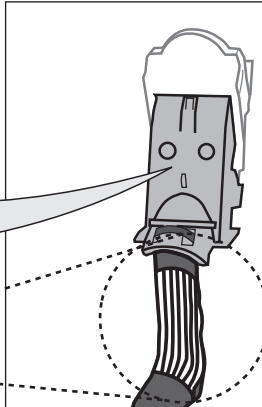
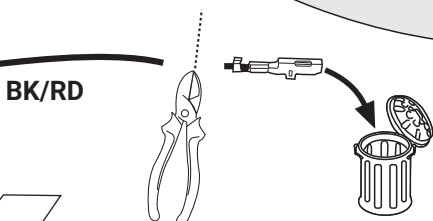

24

OPTION 2

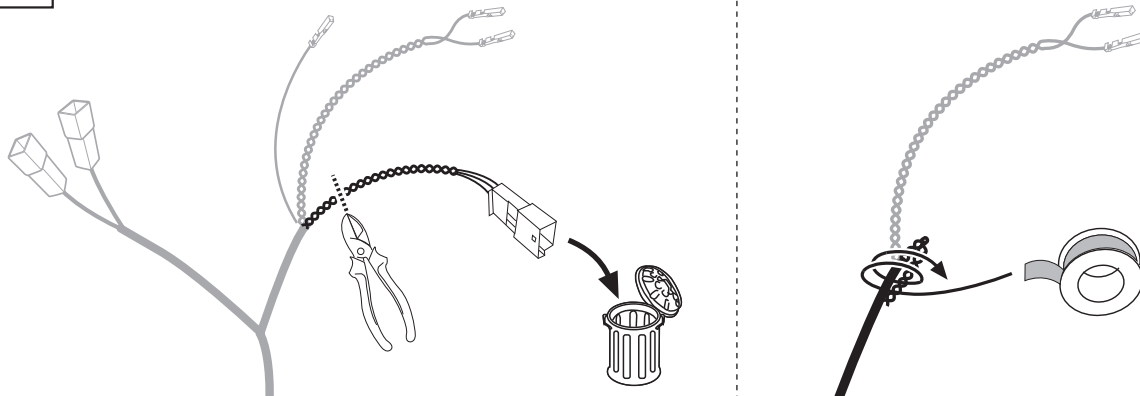

25

**B+/30
Option A**

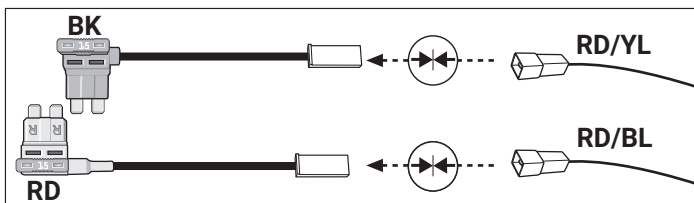

27 - 28
37 - 58

**B+/30
Option B**



29 - 58

26

OPTION A

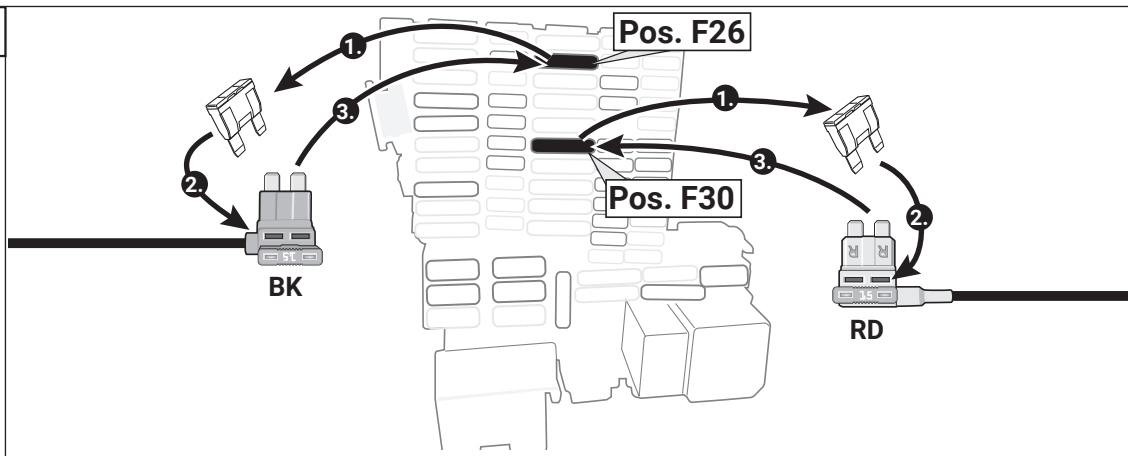
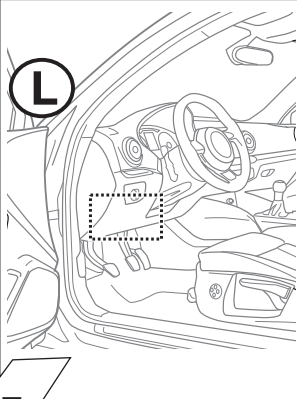

27

OPTION A

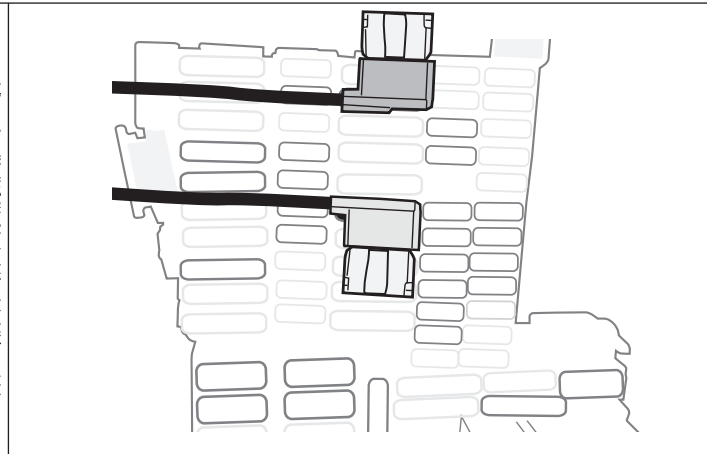
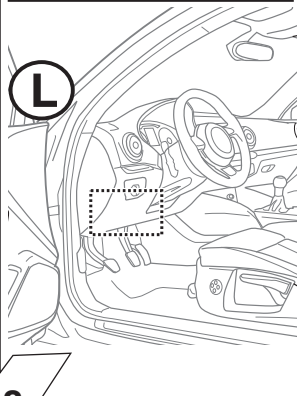

⚠
Wichtig!
Die Sicherungsbrücke darf nicht
in entgegengesetzter Richtung
eingebaut werden!
Important!
Please do not mount the fuse tap
and its wiring output in the other
direction!

28

OPTION B

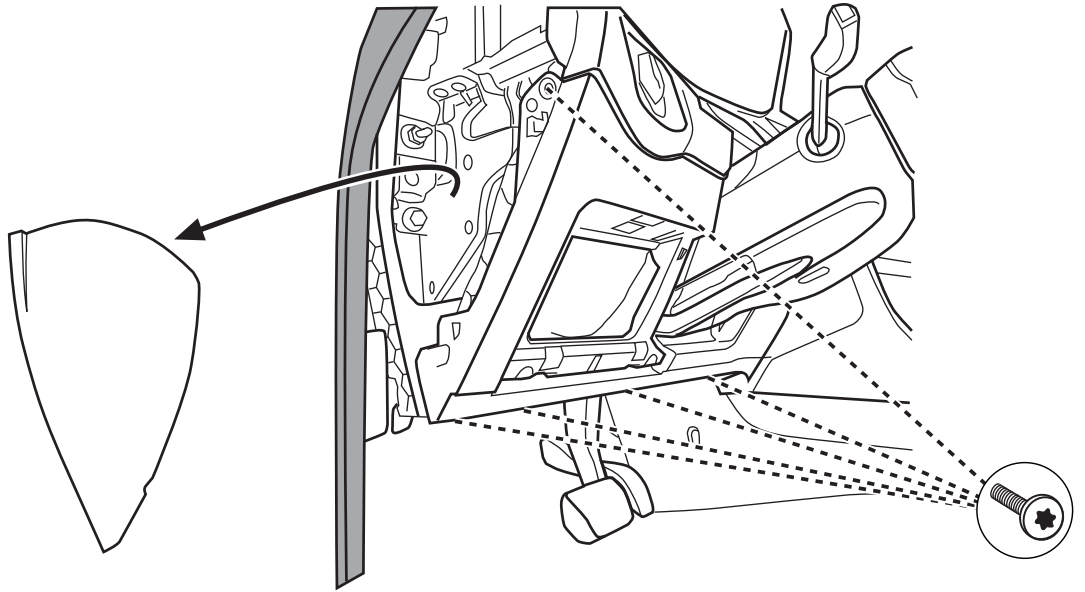
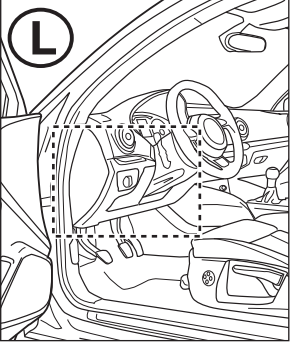

29

OPTION B

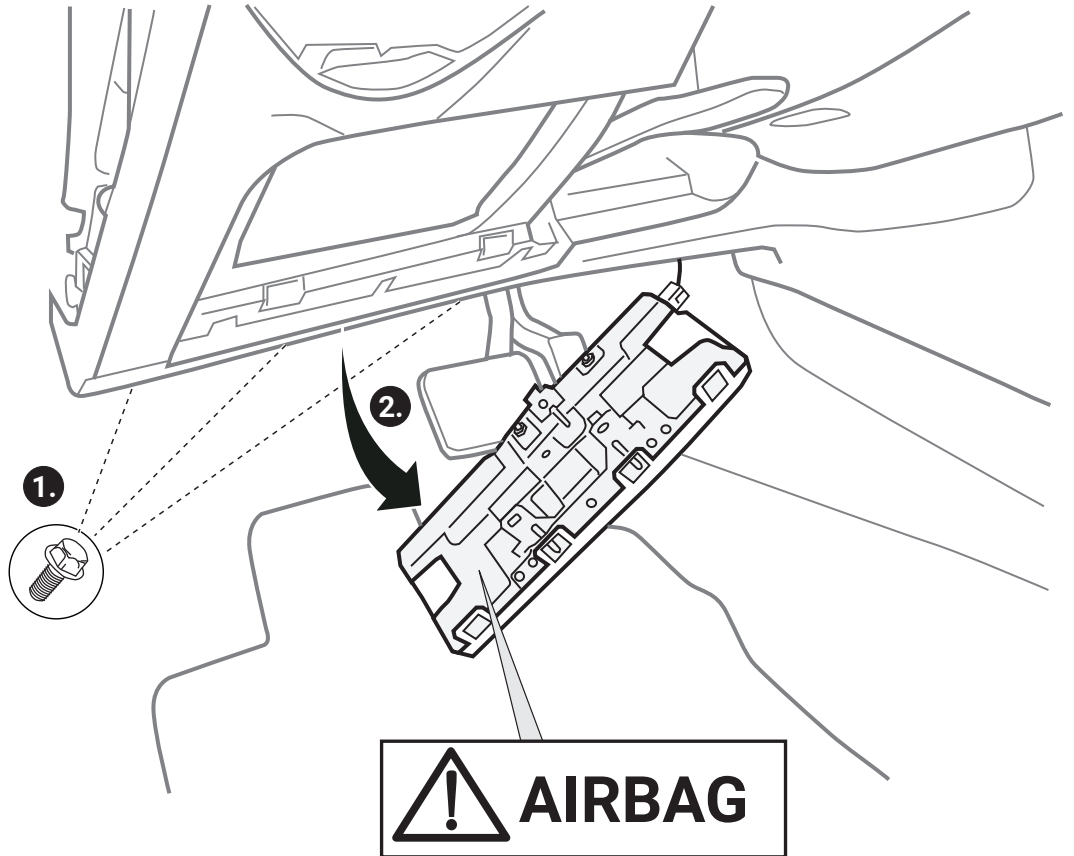
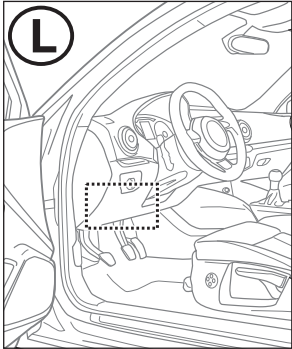

30

OPTION B

L

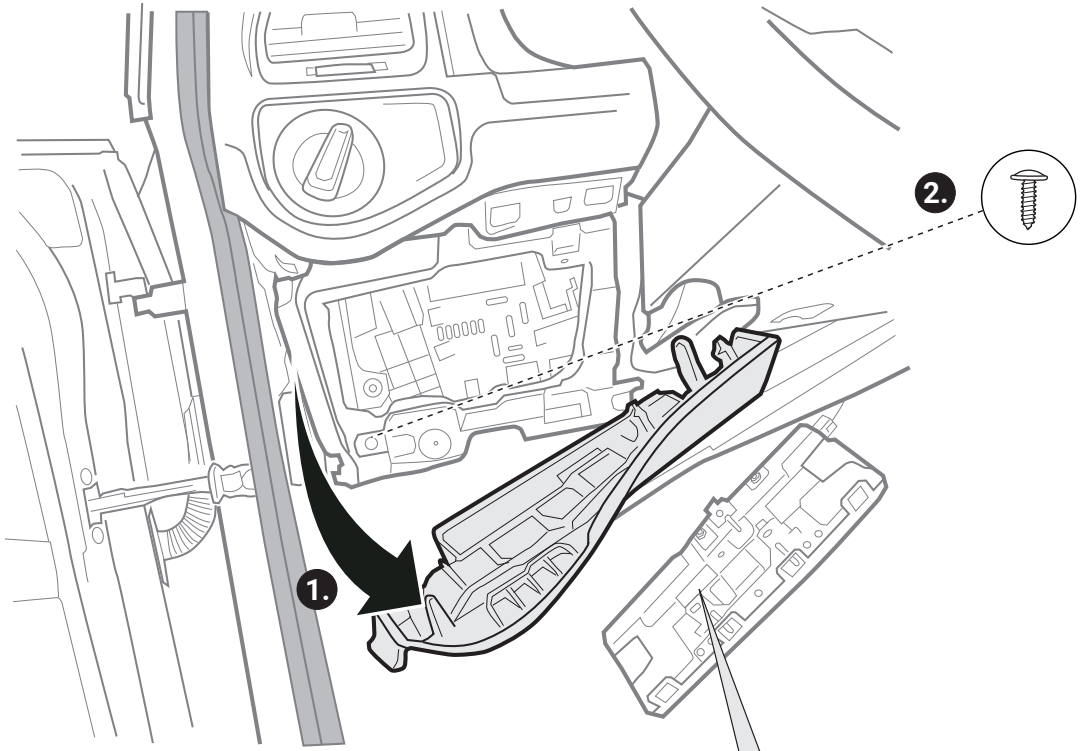
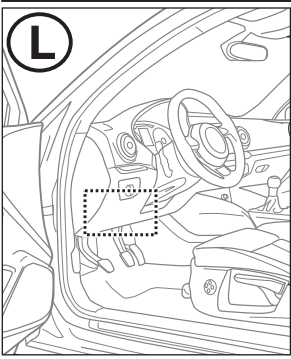

! AIRBAG

31

OPTION B

Demontage Sicherungskasten
Remove Fusebox

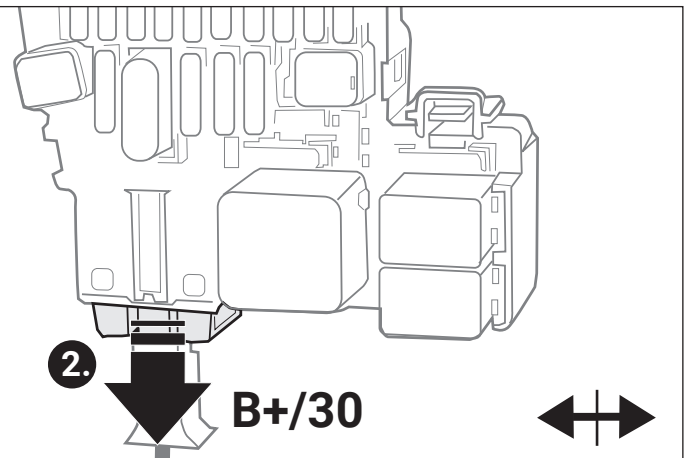
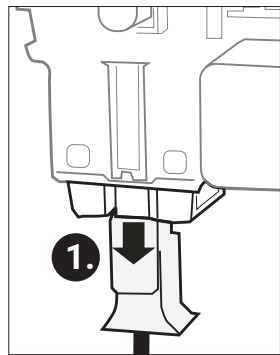
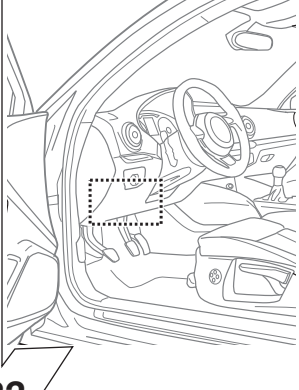

32

OPTION B

Demontage Sicherungskasten
Remove Fusebox

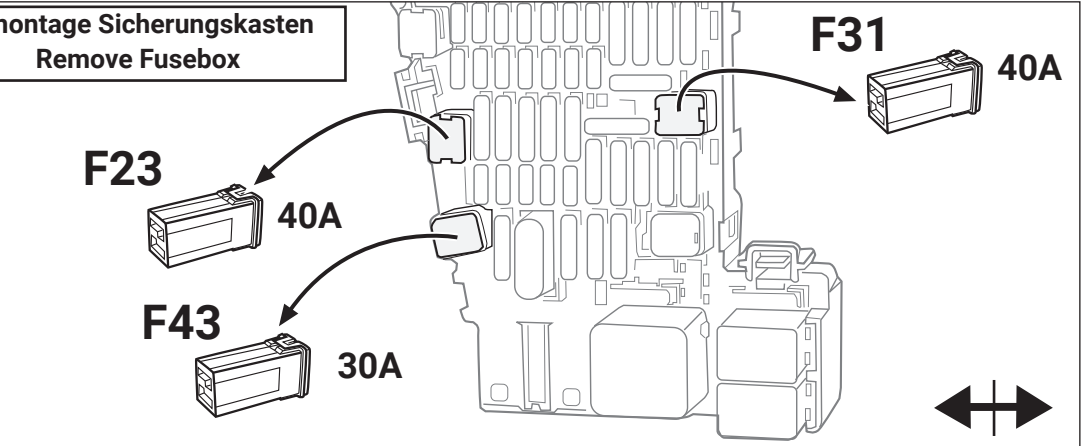
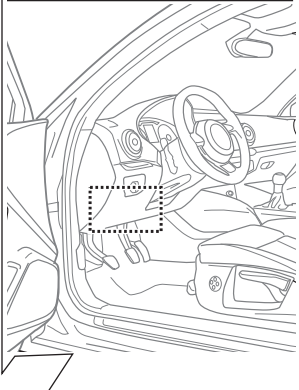

33

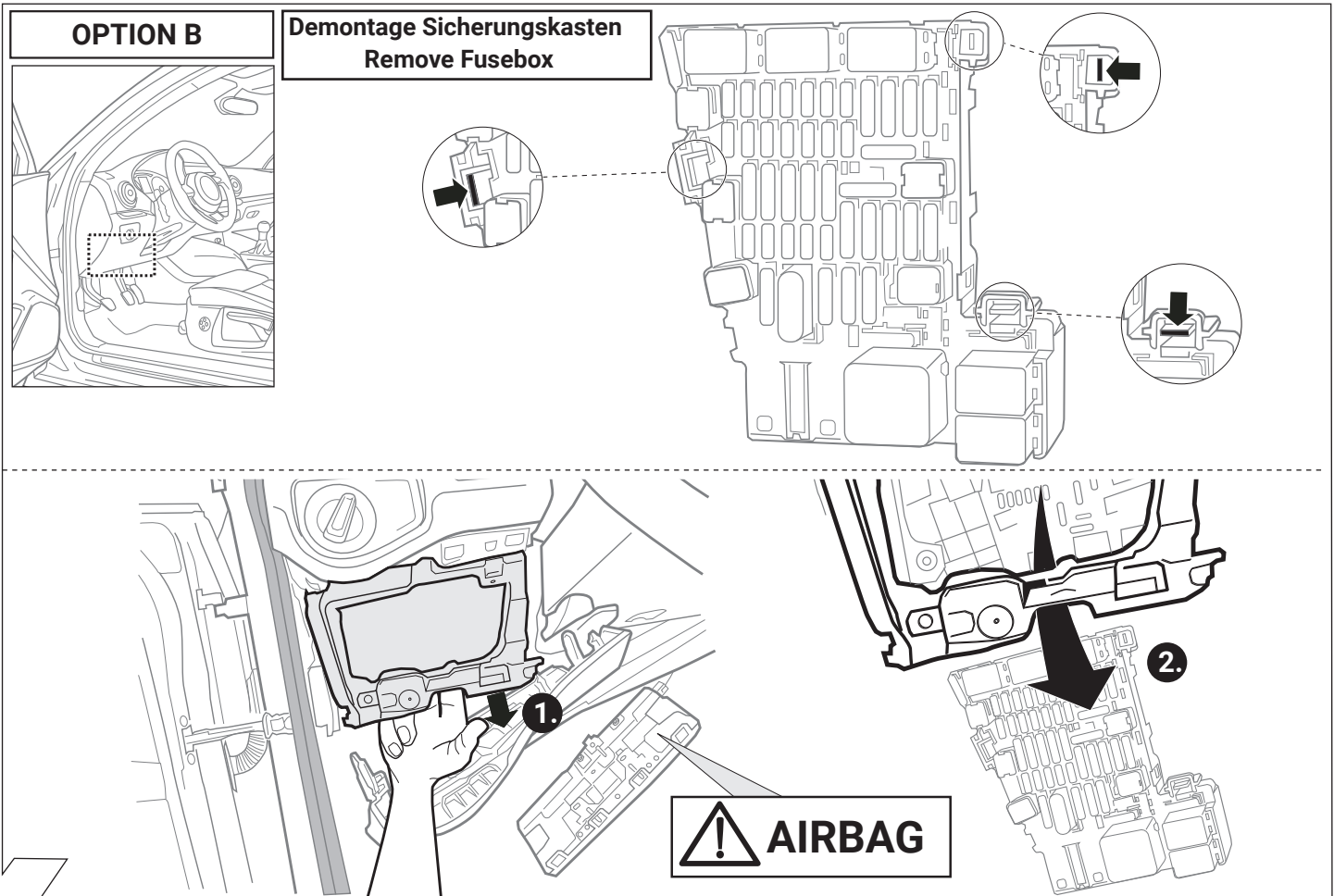

34

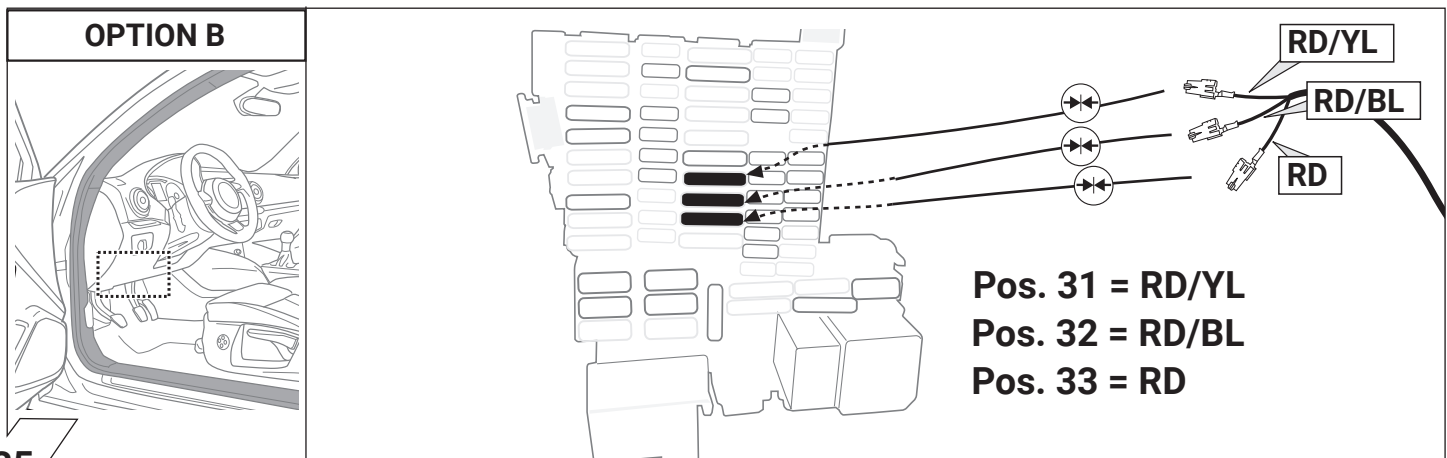

35

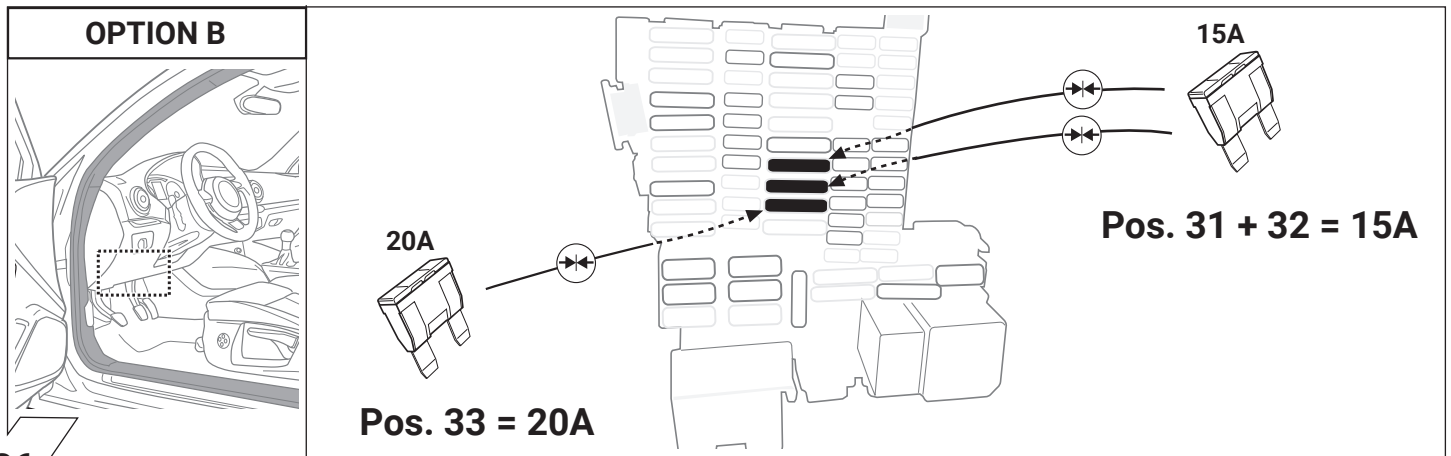

36

OPTION 2

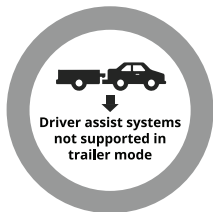
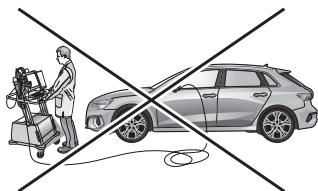

→ 53 - 58

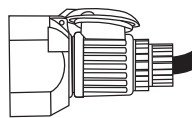

P

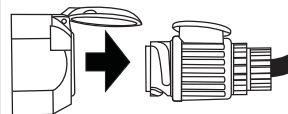

P



42



Folgende Beleuchtungsfunktionen des Anhängers werden **nicht bei allen Zugfahrzeugen mit Tagesfahrlichtschaltung** unterstützt:



- Schlussleuchten
- Begrenzungsleuchten
- Kennzeichenbeleuchtung

Zur Aktivierung dieser Funktionen muss **Stand- oder Abblendlicht eingeschaltet** werden!



Le seguenti funzioni per l'illuminazione del rimorchio **non sono supportate** da tutte le motrici con **circuito di luci diurne**:



- luci posteriori
- luci d'ingombro
- illuminazione targa

Per attivare queste funzioni devono essere accese **le luci di posizione o gli anabbaglianti!**



De volgende verlichtingsfuncties van de aanhanger worden niet bij alle trekkende voertuigen met daglichtschakeling ondersteund:



- Achterlichten
- Spatbordlampen
- Kentekenverlichting

Ter activering van deze functies moet parkeer- of dimlicht worden ingeschakeld!



The following light functions for the trailer are **not supported by all towing vehicles with DRL circuit**:



- Rear lights
- Side lights
- Numberplate lights

The **taillights or dimmed headlights must be switched on** to activate this function!



Les fonctions d'éclairage suivantes de la remorque **ne sont pas activables** sur tous les véhicules de traction équipés de **feux de circulation de jour**:



- Feux arrière
- Feux d'encombrement
- Éclairage de la plaque minéralogique

Pour activer ces fonctions, les feux de position ou de croisement doivent être allumés!



No todos los vehículos tractores con **conmutación de luz de marcha diurna** ofrecen un soporte para las siguientes funciones de iluminación del remolque:



- Luces traseras
- Luces de galibo
- Iluminación de la matrícula

¡Para activar estas funciones deberán encenderse las **luces de posición o las luces de cruce!**

43

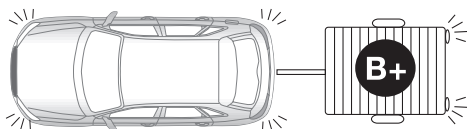
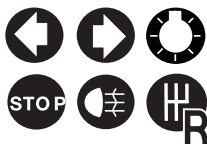

44

OPTIONAL

Trailer Simulator for 7- and 13-pin Sockets

Part-no. 50400522



45

Optional: Adapter socket 62930000

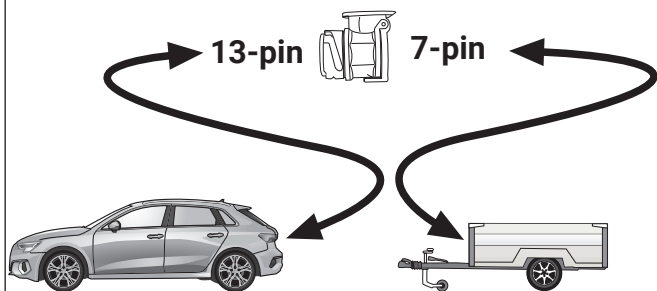

46

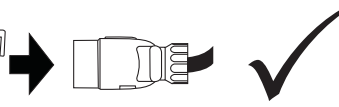
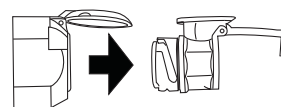
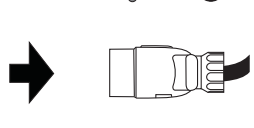
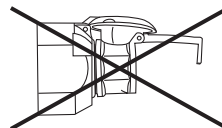

47

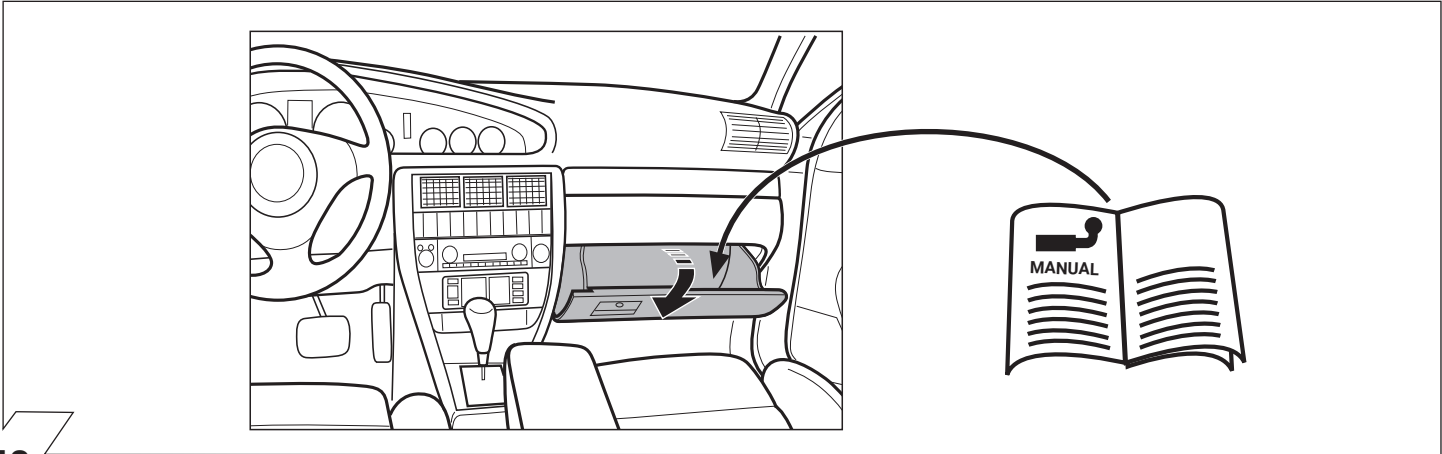

48

OPTION 1

Aktuellste Version:
Latest version:



D

GB

F

Codierung bitte wie folgt durchführen :

Please effect coding as follows :

Veillez suivre le codage suivant :

→ Alternative Diagnosedienstleister bzw. Diagnosemethoden (lokal/offline):

→ Alternative Diagnosis Services or diagnostic methods (local / offline):

→ Diagnostic services alternatives ou les méthodes de diagnostic (local / hors ligne):

- Hella Gutmann (→ 68)
- VCDS (→ 69-70)
- Autologic
- Bosch / KTS
- SP Diagnostic
- SUN
- etc. pp.

- Hella Gutmann (→ 68)
- VCDS (→ 69-70)
- Autologic
- Bosch / KTS
- SP Diagnostic
- SUN
- etc. pp.

- Hella Gutmann (→ 68)
- VCDS (→ 69-70)
- Autologic
- Bosch / KTS
- SP Diagnostic
- SUN
- etc. pp.

I

E

NL

Favor e codifica ef fettuate come segue:

Por favor de codificación lleva a cabo como sigue:

Gelieve codering als volgt uitvoeren:

→ Alternativa Diagnosi Servizio o metodi diagnostici (locale / offline):

→ Servicio de Diagnóstico Alternativa o métodos de diagnóstico (locales / fuera de línea):

→ Alternatief Diagnose Dienst of diagnostische methoden (lokale / offline):

- Hella Gutmann (→ 68)
- VCDS (→ 69-70)
- Autologic
- Bosch / KTS
- SP Diagnostic
- SUN
- etc. pp.

- Hella Gutmann (→ 68)
- VCDS (→ 69-70)
- Autologic
- Bosch / KTS
- SP Diagnostic
- SUN
- etc. pp.

- Hella Gutmann (→ 68)
- VCDS (→ 69-70)
- Autologic
- Bosch / KTS
- SP Diagnostic
- SUN
- etc. pp.

OPTION 1

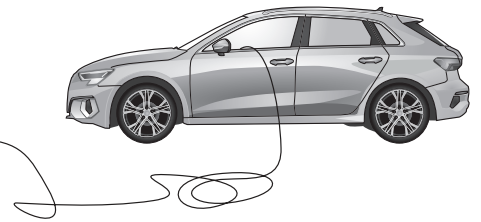
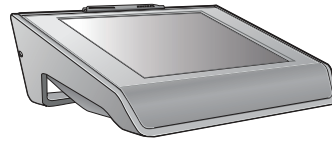

(D)

Die Aktivierung der Anhängerfunktionen muss wie folgt durchgeführt werden:

1. Fahrzeugauswahl
2. In Diagnose wechseln - Codierung
3. Anhängerkupplung de-/aktivieren
4. Diagnose Interface Bus auswählen
5. Anleitung folgen

Fahrzeuge mit Assistenzsystemen

6. AHK an Assistenzsysteme anpassen ausführen
7. Anleitung folgen
8. Diagnose
9. Fehlerspeicher auslesen, ggf. löschen
10. Fertig

(GB)

The activation of the trailer functions must be performed as follows:

1. Vehicle selection
2. switch to diagnostics - coding
3. Deactivate/activate trailer coupling
4. Select diagnostic Interface Bus
5. Follow instructions

Vehicles with assistance systems

6. Perform adaptation of trailer coupling on assistance systems
7. Follow instructions
8. Diagnostics
9. Read out error memory, delete if necessary
10. Done

(F)

Pour activer l'attelage, procéder de la façon suivante :

1. Choix véhicule
2. Aller dans le diagnostic - codage
3. Activer/désactiver le diagnostic
4. Sélectionner le BUS d'interface de diagnostic
5. Suivre les instructions

Véhicules avec systèmes d'aide

6. Effectuer une adaptation d'attelage aux systèmes d'aide
7. Suivre les instructions
8. Diagnostic
9. Lire la mémoire de défaut et effacer les codes d'erreur éventuellement mémorisés
10. Terminé

(I)

Per attivare le funzioni del rimorchio, procedere nel modo seguente:

1. Scelta vettura
2. Passare alla >Diagnosi< - Codifica
3. Attivare / disattivare il gancio di traino
4. Selezionare il interfaccia di diagnosi
5. Seguire le istruzioni

Veicoli con sistemi di assistenza

6. Adattare i sistemi installati
7. Seguire le istruzioni
8. Diagnosi
9. Leggere la memoria guasti e cancellare, se necessario
10. Terminato

(E)

La activación de las funciones de remolque debe realizarse de la siguiente manera:

1. Selección de vehículo
2. Cambiar a diagnosis - Codificación
3. Desactivar/activar acoplamiento para remolque
4. Seleccionar diagnosis Interface Bus
5. Seguir las instrucciones

En vehículos con sistemas de asistencia

6. Ejecutar adaptación de acoplamiento para remolque a sistemas de asistencia
7. Seguir las instrucciones
8. Diagnosi
9. Leer memoria de averías y borrarla si es necesario
10. Listo

(NL)

De activering van de aanhangerfuncties moet als volgt worden uitgevoerd.:

1. Voertuigselectie
2. Ga naar Diagnose - Codering
3. Aanhangwagenkoppeling deactiveren/activeren
4. Diagnose interface bus selecteren
5. Volg instructie op

Bij voertuigen met assistentiesystemen

6. "Aanhangwagenkoppeling aanpassen aan assistentiesystemen" uitvoeren
7. Volg instructie op
8. Diagnose
9. Foutcodegeheugen uitlezen en indien nodig wissen
10. Gereed

OPTION 1

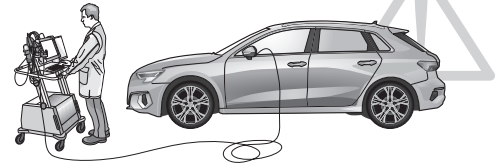

D

Codierung VW/Audi/Seat/Skoda mit VCDS

Bitte beachten :

Der nachfolgend beschriebene Ablauf zur Codierung bzw. Freischaltung auf Anhängerbetrieb dient lediglich zur allgemeinen Orientierung und kann je nach Modell (Motorisierung/ Ausstattung) stark variieren. Gegebenenfalls müssen weniger oder noch weitere Steuergeräte angepasst werden.

- **Codierung Gateway_19 (Diagnoseinterface)**
Verbauliste ->
69 Anhänger -> verbaut
- **Codierung EZE_09 (Elektronisches Zentralelektrik-Steuergerät):**
Zugriffsberechtigung: 31347
Anpassung -10
Anpassungskanal:
Vernetzung
Anhängeranschlussgerät -> verbaut
Trailer Hitch Control Module -> verbaut
- **Codierung DIS_13 (Distanzregelung)**
Zugriffsberechtigung: 20103
Codierung
Control Module for Trailer -> verbaut
- **Codierung ZKS_46 (Zentralmodul Komfortsystem)**
Trailer control unit -> verbaut
- **Codierung SWA_3C (Spurwechselassistent)**
Trailer control unit -> verbaut
- **Codierung SCH_17 (Schalttafeleinsatz)**
Trailer control unit -> verbaut
- **Codierung RFK_6C (Rückfahrkamerasystem)**
Anhängererkennung -> verbaut
- **Codierung STF_74 (Fahrwerkssteuerung)**
Anhänger -> verbaut
- **Codierung EPH_10 (Einparkhilfe Steuergerät)**
Anhänger -> Anhängervorrichtung manuell abnehmbar
- **Codierung FFF_A5 (Frontsensorik Steuergerät)**
Anhängerelektronik -> verbaut
- **Codierung HDE_6D (Heckdeckelelektronik Steuergerät)**
Steuergerät für Anhänger -> verbaut

Wichtiger Hinweis zur Codierung bzw. Freischaltung auf Anhängerbetrieb.

Die vorab genannten Einstellungen werden im Bordnetz des Fahrzeuges vorgenommen und lokal abgespeichert. Bei generellen Updates der Fahrzeugsoftware (beispielsweise im Rahmen von Service- oder Instandsetzungsarbeiten), können diese Einstellungen unter Umständen wieder überschrieben und gelöscht werden. In diesem Fall muss die Freischaltung auf Anhängerbetrieb nach dem Update noch einmal lokal aktualisiert werden.

GB

Encoding VW/Audi/Seat/Skoda with VCDS

Please note :

The procedure described below for encoding and enabling the trailer mode only serves for a general orientation and can vary greatly depending on the model (motorisation / equipment). If necessary, fewer or further control units will have to be adapted.

- **Encoding Gateway_19**
Installations List ->
69 Trailer hitch control module -> installed
- **Encoding EZE_09 (electronic central electric controller):**
Access authorisation: 31347
Adaptation -10
Adaptation channel:
networking trailer connection device -> installed
Trailer hitch control module -> installed
- **Encoding DIS_13 (distance control)**
Access authorisation 20103
Encoding
Control module for trailer -> installed
- **Encoding ZKS_46 (central module comfort system)**
Trailer control unit -> installed
- **Encoding SWA_3C (lane change assistant)**
Trailer control unit -> installed
- **Encoding SCH_17 (control panel insert)**
Trailer control unit -> installed
- **Encoding RFK_6C (reversing camera system)**
Trailer detection -> installed
- **Encoding STF_74 (chassis control)**
Trailer -> installed
- **Encoding EPH_10 (PDC controller)**
Trailer -> Trailer device
can be removed manually
- **Encoding FFF_A5 (front sensor system controller)**
Trailer electronics -> installed
- **Encoding HDE_6D (boot lid electronics controller)**
Controller for trailer -> installed

Important note on encoding and activating in trailer mode.

The aforementioned settings are carried out in the vehicle's electrical system and saved locally. During general updates for the vehicle software (for example, within the scope of service or repair work), the settings may be overwritten and deleted under certain circumstances. In this case, the trailer mode activation has to be updated again locally after the update.

F

Codage VW/Audi/Seat/Skoda avec VCDS

Attention :

Le déroulement du codage et de l'activation du fonctionnement avec remorque décrit ci-après sert uniquement d'information générale et peut varier fortement d'un modèle à l'autre (motorisation / équipement). Le cas échéant, il faudra ajuster moins ou au contraire plus d'appareils de commande.

- **Codage Gateway_19**
Installations List ->
69 Trailer hitch control module -> monté
- **Codage EZE_09 (appareil de commande électronique de la centrale électrique):**
Autorisation d'accès: 31347
Ajustement -10
Canal d'ajustement:
mise en réseau de l'appareil de connexion de la remorque montée
Trailer Hitch Control Module -> monté
- **Codage DIS_13 (réglage de la distance)**
Autorisation d'accès 20103
Codage
Control Modul for Trailer -> monté
- **Codage ZKS_46 (module central système confort)**
Trailer control unit -> monté
- **Codage SWA_3C (assistant de changement de file)**
Trailer control unit -> monté
- **Codage SCH_17 (porte-instruments)**
Trailer control unit -> monté
- **Codage RFK_6C (système de caméra de marche arrière)**
Identification de la remorque -> montée
- **Codage STF_74 (commande du châssis)**
Remorque -> montée
- **Codage EPH_10 (appareil de commande aide au stationnement)**
Remorque -> Dispositif de remorque démontable à la main
- **Codage FFF_A5 (appareil de commande capteurs avant)**
Électronique de la remorque -> montée
- **Codage HDE_6D (appareil de commande de l'électronique du hayon)**
Appareil de commande pour débutants -> monté

Remarque importante sur le codage et l'activation du fonctionnement avec remorque.

Les réglages mentionnés ci-dessus sont effectués dans le réseau de bord du véhicule et sauvegardés localement. Pour les mises à jour générales du logiciel du véhicule (par exemple dans le cadre de travaux d'entretien ou de réparation), ces réglages peuvent dans certains cas être écrasés et supprimés. Dans ce cas, l'activation du fonctionnement avec remorque doit être encore une fois actualisée localement après la.

OPTION 1

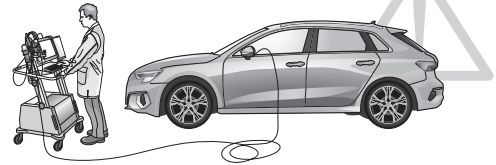

I	E	NL
<p>Codifica VW/Audi/Seat/Skoda con VCDS</p> <p>Attenzione :</p> <p>Il procedimento di codifica o abilitazione a esercizio con rimorchio descritto qui di seguito serve esclusivamente come orientamento generale e può variare radicalmente a seconda del modello (motorizzazione/dotazione). È possibile che alcune o ancora altre centraline debbano essere adeguate.</p> <p>→ Codifica Gateway_19 Installations List -> Trailer hitch control module -> installato</p> <p>→ Codifica EZE_09 (centralina del sistema elettrico centrale elettronico): Autorizzazione all'accesso: 31347 Adeguamento -10 Canale di adeguamento: collegamento apparecchio a rimorchio installato Trailer Hitch Controll Module -> installato</p> <p>→ Codifica DIS_13 (regolazione distanza) Autorizzazione all'accesso 20103 Codifica Control Modul for Trailer -> installato</p> <p>→ Codifica ZKS_46 (modulo centrale sistema comfort) Trailer control unit -> installato</p> <p>→ Codifica SWA_3C (assistente cambio di corsia) Trailer control unit -> installato</p> <p>→ Codifica SCH_17 (quadro strumenti) Trailer control unit -> installato</p> <p>→ Codifica RFK_6C (telecamera retromarcia) Riconoscimento rimorchio -> installato</p> <p>→ Codifica STF_74 (sistema di controllo del telaio) Rimorchio -> installato</p> <p>→ Codifica EPH_10 (centralina ausilio di parcheggio) Rimorchio dispositivo rimorchio rimovibile manualmente</p> <p>→ Codifica FFF_A5 (centralina sensori frontali) Sistema elettronico rimorchio -> installato</p> <p>→ Codifica HDE_6D (centralina sistema elettronico portellone portabagagli) Centralina per rimorchio + installata</p> <p>Avvertenza importante per la codifica o l'attivazione per funzionamento con rimorchio.</p> <p>Le impostazioni indicate in precedenza vengono effettuate nella rete di bordo del veicolo e memorizzate localmente. Nel caso di update generali del software del veicolo (ad esempio nell'ambito di lavori di assistenza o messa a punto) in particolari circostanze è possibile sovrascrivere e cancellare nuovamente queste impostazioni. In questo caso dopo l'update l'attivazione per funzionamento con rimorchio deve essere aggiornata di nuovo localmente.</p>	<p>Codificación VW/Audi/Seat/Skoda con VCDS</p> <p>Atención :</p> <p>El proceso de codificación y/o habilitación descrito a continuación es una mera orientación general y puede variar considerablemente en función del modelo (motorización / equipamiento). Según el caso será necesario adaptar un mayor o menor número de unidades de control.</p> <p>→ Encoding Gateway_19 Installations List -> Trailer hitch control module -> montado</p> <p>→ Codificación EZE_09 (unidad de control electrónica del sistema eléctrico central): Autorización de acceso: 31347 Adaptación -10 Canal de adaptación: Interconexión unidad de control de remolque montada Trailer Hitch Controll Module -> montado</p> <p>→ Codificación DIS_13 (regulación de distancia) Autorización de acceso 20103 Codificación Control Modul for Trailer -> montado</p> <p>→ Codificación ZKS_46 (módulo central del sistema de confort) Trailer control unit -> montada</p> <p>→ Codificación SWA_3C (asistente de cambio de carril) Trailer control unit -> montada</p> <p>→ Codificación SCH_17 (utilización del cuadro de distribución) Trailer control unit -> montada</p> <p>→ Codificación RFK_6C (sistema de cámaras de marcha atrás) Identificación de remolque -> montada</p> <p>→ Codificación STF_74 (control de chasis) Remolque -> montado</p> <p>→ Codificación EPH_10 (unidad de control del sistema de ayuda al aparcamiento) Remolque -> Dispositivo de remolque desmontable a mano</p> <p>→ Codificación FFF_A5 (unidad de control del sistema de sensores frontales) Sistema electrónico de remolque -> montado</p> <p>→ Codificación HDE-6D (unidad de control del sistema electrónico de la puerta del maletero): Unidad de control para remolque -> montada</p> <p>Nota importante sobre la codificación y/o habilitación del modo remolque. Los ajustes anteriormente mencionados se llevan a cabo en el sistema eléctrico de a bordo y se guardan de forma local. En caso de actualizaciones generales (por ejemplo, con motivo de trabajos de mantenimiento o reparación), puede que se vuelvan a sobrescribir y borrar estos ajustes. En tal caso se debe volver a actualizar la habilitación del modo remolque de forma local después de la actualización.</p>	<p>Codering VW/Audi/Seat/Skoda met VCDS</p> <p>Gelieve in acht nemen :</p> <p>De hierna beschreven procedure voor de codering resp. vrijgave voor het gebruik met aanhangwagen dient louter voor een algemene oriëntatie en kan, afhankelijk van het model (motorisering / uitrusting), sterk variëren. Eventueel moet er minder of nog andere bedieningsapparaten aangepast worden.</p> <p>→ Codering Gateway 19 Installations List -> Trailer hitch control module -> ingebouwd</p> <p>→ Codering EZE_09 (elektronisch bedieningsapparaat "Centrale elektriciteit"): Toegangsbevoegdheid: 31347 Aanpassing -10 Aanpassingskanaal: Koppeling aansluitapparaat aanhangwagen ingebouwd Trailer Hitch Controll Module -> ingebouwd</p> <p>→ Codering DIS_13 (afstandsregeling) Toegangsbevoegdheid 20103 Codering Control Modul for Trailer -> ingebouwd</p> <p>→ Codering ZKS_46 (centrale module comfortsysteem) Trailer control unit -> ingebouwd</p> <p>→ Codering SWA_3C (spoorwisselassistent) Trailer control unit -> ingebouwd</p> <p>→ Codering SCH_17 (gebruik schakelpaneel) Trailer control unit -> ingebouwd</p> <p>→ Codering RFK_6C (terugrijd-camerasysteem) Detectie aanhangwagen -> ingebouwd</p> <p>→ Codering STF_74 (chassisbesturing) Aanhangwagen -> ingebouwd</p> <p>→ Codering EPH_10 (parkeerhulp bedieningsapparaat) Aanhangwagen Aanhanginrichting handmatig afneembaar</p> <p>→ Codering FFF_A5 (frontale sensoriek bedieningsapparaat) Elektronica aanhangwagen -> ingebouwd</p> <p>→ Codering HDE_6D (elektronica achterdek bedieningsapparaat) Bedieningsapparaat voor aanhangwagen + ingebouwd</p> <p>Belangrijke aanwijzing voor codering resp. vrijgave voor gebruik met aanhangwagen.</p> <p>De vooraf vermelde instellingen worden in het boordnet van het voertuig doorgevoerd en lokaal opgeslagen. Bij algemene updates van de voertuigsoftware (bijvoorbeeld in het kader van service- of instandhoudingswerkzaamheden) kunnen deze instellingen soms weer overschreven en gewist worden. In dit geval moet de vrijgave voor het gebruik met aanhangwagen na de update nogmaals lokaal geactualiseerd worden.</p>

OPTION 2



53

OPTION 2

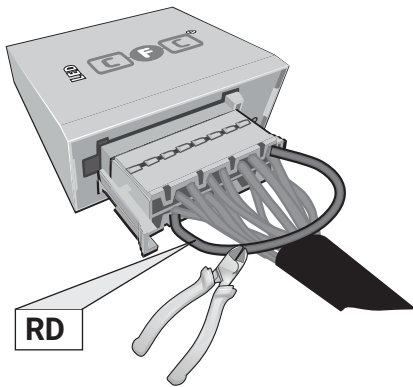

Pin 11 and Pin 2 disconnected
Pin 11 and Pin 2 unterbrochen

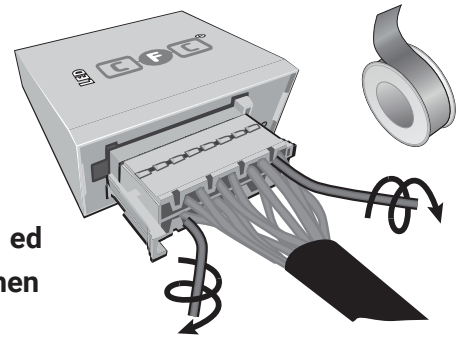

54

OPTION 2

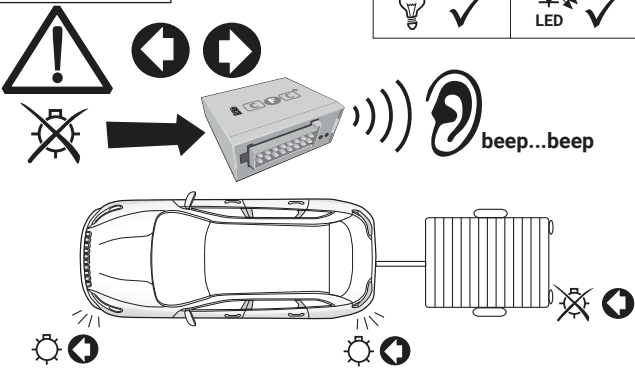

55

OPTION 2

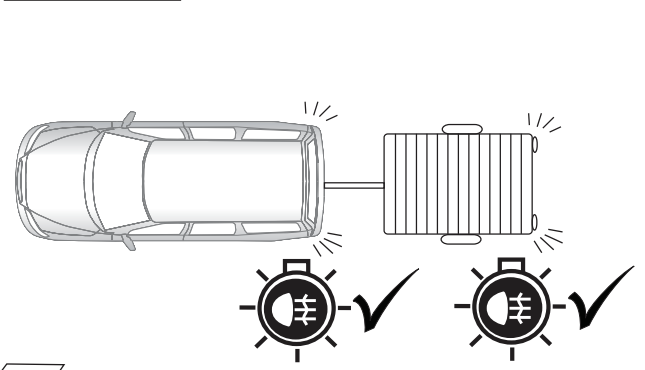

56

OPTION 2

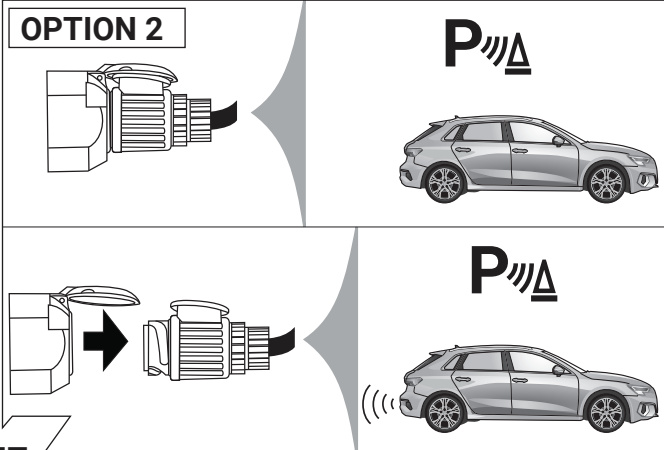





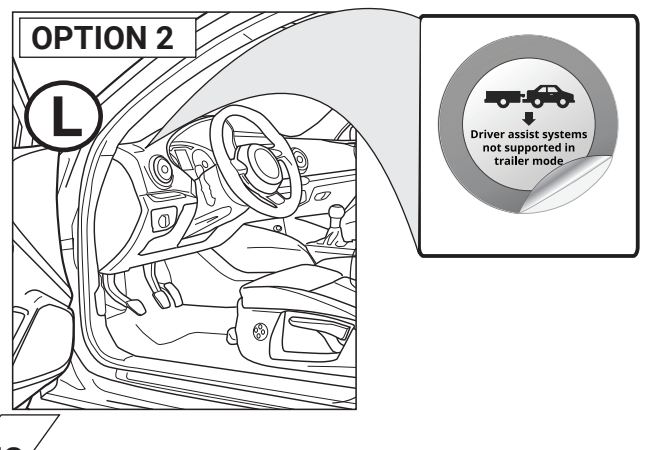



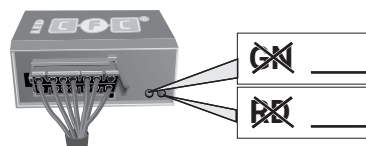



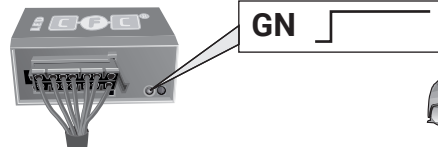



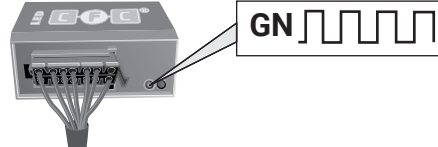

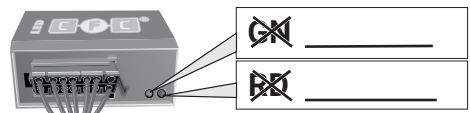
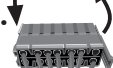
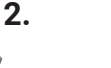
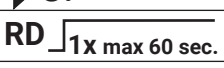
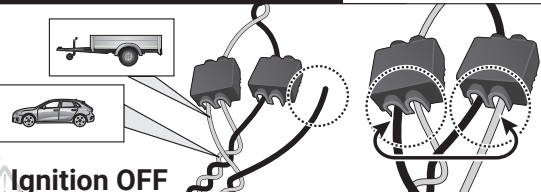
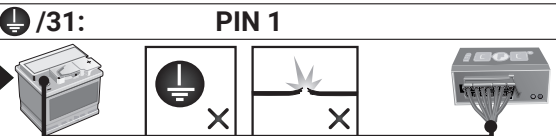

57

OPTION 2

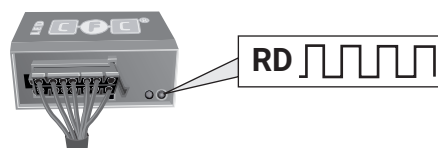

58

D Diagnosefunktion der Kontroll-LED's	GB Diagnosis function of control LEDs	F Fonction diagnostic des LED de contrôle
I Funzione di diagnostica dei LED di controllo	E Función de diagnóstico de los LEDs de control	NL Diagnosefunctie van de controle-LED's
  <p>Ignition OFF</p>	<p>No CAN-Data =  Standby / Sleepmode </p>	
  <p>Ignition ON</p>	 	
  <p>Ignition ON</p>	 	
  <p>Ignition ON</p> <p>1.  2.  3.  RD 1x max 60 sec.</p>	<p>CAN-Data Wire PIN 13+14</p>  <p>Ignition OFF</p> <p>oder / or</p> <p>/31: PIN 1</p>   	
  <p>Ignition ON</p> <p>RD </p>	<p>B+/30: PIN 2 oder / or 4</p>  	
<p>D Blinküberwachung und Leuchten-Substitution bei Ausfall der Anhänger-Blinkleuchten</p> <p>Der Ausfall von einer oder von beiden Anhänger-Blinkleuchten wird je nach Fahrzeugtyp und Ausführung des verbauten Elektro-Einbausatzes wie folgt angezeigt:</p> <ul style="list-style-type: none"> • Erhöhung / Verdoppelung der Blinkfrequenz • Volltextmeldung im Display / Kombi-Instrument • Aktivierung Kontrollleuchte für Lampenausfall • Akustische Warnung via Buzzer oder Voice-Message <p>Bei einem Blinkleuchten-Ausfall ersetzt die gleichseitige Rückleuchte durch Aufleuchten in der Blinkfrequenz eine defekte Anhänger-Blinkleuchte (▶ Leuchten-Substitution!).</p>	<p>GB Indicator failure detection and lamp substitution if the trailer indicators fail</p> <p>The failure of a single or on both trailer indicators will be shown depending on the type of vehicle and electric kit installed as follows:</p> <ul style="list-style-type: none"> • Increase in the flashing frequency • Text message in the Display / combi-instrument • Activated control lamp for light failure • Audible warning via Buzzer or Voice-Message <p>If an indicator fails the left or right rear light compensates the faulty indicator by flashing at the correct frequency! (▶ lamp substitution).</p>	
<p>F Surveillance des clignotants et substitution des feux en cas de panne des clignotants de la remorque</p> <p>La panne d'un ou des deux clignotants de la remorque est indiquée de la façon suivante en fonction du type de véhicule et du modèle de module électrique monté:</p> <ul style="list-style-type: none"> • Augmentation / doublement de la fréquence de clignotement • Message complet sur l'affichage / l'instrument combiné • Activation du voyant de contrôle pour panne de lampe • Avertissement sonore via buzzer ou message vocal <p>En cas de panne de clignotant, le feu arrière du côté de la panne remplace un clignotant de remorque défectueux en s'allumant à la même fréquence que le clignotant! (▶ Substitution des feux!).</p>	<p>I Controllo delle frecce e sostituzione delle lampade in caso di guasto alle frecce del rimorchio</p> <p>A seconda del tipo di veicolo e della versione del kit elettrico montato, il guasto di una o di entrambe le frecce del rimorchio si manifesta come segue:</p> <ul style="list-style-type: none"> • Aumento/raddoppio della frequenza di lampeggiamento • Full text display / strumento combinato • Attivazione della spia di controllo per il guasto lampada • Segnalazione acustica mediante cicalino o messaggio vocale <p>In caso di guasto alla luce della freccia, la luce posteriore dello stesso lato si accende sostituendo nella frequenza del lampeggio la freccia difettosa del rimorchio. (▶ Sostituzione delle lampade!).</p>	
<p>E Control de intermitentes y sustitución de lámparas en caso de fallo de los intermitentes del remolque</p> <p>El fallo de uno o de ambos intermitentes del remolque se indicará de la siguiente manera en función del tipo del vehículo y de la ejecución del juego de montaje eléctrico montado:</p> <ul style="list-style-type: none"> • Aumento/duplicación de la frecuencia de parpadeo • Mensaje de texto completo en el display/instrumento combinado • Activación de la lámpara piloto para el fallo de lámparas • Advertencia acústica mediante zumbador o mensaje de voz <p>Si hay un fallo de intermitente, la luz trasera del mismo lado reemplazará la lámpara defectuosa del intermitente parpadeando en la misma frecuencia que el intermitente (▶ Sustitución de lámparas!).</p>	<p>NL Knippercontrole en lampvervanging bij uitval van de knipperlampen van een aanhangwagen</p> <p>De uitval van één of beide knipperlampen van een aanhangwagen wordt afhankelijk van het voertuigtype en de uitvoering van de ingebouwde elektroset als volgt aangegeven:</p> <ul style="list-style-type: none"> • Verhoging / verdubbeling van de knipperfrequentie • Volledige tekstweergave op het display / combi-instrument • Activering controlelampje voor uitval van een lamp • Akoestische waarschuwing via buzzer of Voice-Message <p>Bij een uitval van (een) knipperlamp(en) vervangt het gelijkzijdige achterlicht door aan te flitsen bij de knipperfrequentie een defecte knipperlamp van een aanhangwagen (▶ Lampvervanging!).</p>	

ERKLÄRUNG SYMBOLE	SYMBOL EXPLANATION	EXPLICATION DES SYMBOLES	SPIEGAZIONE DEI SIMBOLI	EXPLICACIÓN DE LOS SIMBOLES	VERKLARING SYMBOLEN
(D)	(GB)	(F)	(I)	(E)	(NL)
linke (58-L) bzw. rechte (58-R) Schlussleuchte	left (58-L) respectively right (58-R) tail light	feu arrière gauche (58-L) respectivement droite (58-R)	luce posteriore sinistra (58-L) rispettivamente destra (58-R)	pilato trasero izquierdo (58-L) respectivamente derecho (58-R)	Linker (58-L) c.q. rechter (58-R) achterlicht
Bremsleuchte (54) / 3. Bremsleuchte (54)	stop light (54) / high mounted, third stop light (54)	feu de stop (54) / 3ième feu de stop (54)	luce d'arresto (54) / 3. luce d'arresto (54)	luz de freno (54) / tercera luz de freno (54)	Remlicht (54) / 3e remlicht (54)
Fahrtrichtungsanzeiger links	turn signal indicator left	feu indicateur de direction gauche	indicatore di direzione sinistra	luz indicadora de dirección de marcha izquierda	Richtingaanwijzer links
Fahrtrichtungsanzeiger rechts	turn signal indicator right	feu indicateur de direction droite	indicatore di direzione destra	luz indicadora de dirección de marcha derecha	Richtingaanwijzer rechts
Nebelschlussleuchte(n)	rear fog light(s)	feu (x) arrière (s) de brouillard	fendinebbia	luz (-ces) trasera (s) antineblia (s)	Mistachterlicht(en)
Rückfahrleuchte(n)	reversing light(s)	feu (x) de marche arrière	luce (i) retromarcia	luz (-ces) de marcha atrás	Achteruitrijlicht(en)
Dauerstrom / Steckdose 13P Kammer 9	Permanent power supply / 13pin socket, chamber 9	courant continue / prise de courant à 13 pôles, compartiment 9	alimentazione continua / presa 13 poli, camera 9	positivo continuo / caja de anclaje a 13 polos, cámara 9	Continuustroom / stekker doos 13P kamer 9
Ladeleitung / Steckdose 13P Kammer 10	charging wire for trailer battery / 13pin socket, chamber 10	cable de charge / prise de courant à 13 pôles, compartiment 10	cavo di carica / presa 13 poli, camera 10	cable de carga / caja de anclaje a 13 polos, cámara 10	Laadaad / stekkerdoos 13P kamer 10
Anhänger / Anhängererkennung	trailer / trailer recognition	remorque / "remorque" détection de la fonction "remorque"	rimorchio / riconoscimento rimorchio	remolque / detección del remolque	Aanhanger / aanhangeridentificatie
Dauerstrom / permanente Stromversorgung	Permanent current power supply	courant continue / alimentation électrique permanente	corrente / alimentazione continua	positivo continuo / alimentación de corriente permanente	Continuustroom / permanente stroomvoorziening
Masse (31)	Ground or Earth (31)	masse (31)	masse (31)	masa (31)	Massa (31)
Batteriepolklemme Anschluss Minus	ground connection battery terminal lug	borne "moins" de la batterie	connessione negativa della batteria	conexión negativa de batería	Accupoolklem aansluiting min
Batteriepolklemme Anschluss Plus	positive connection battery terminal lug	borne "plus" de la batterie	connessione positiva della batteria	conexión positiva de batería	Accupoolklem aansluiting plus
Sicherung / Sicherungsstärke 20 Ampère	fuse / fuse capacity 20 Ampère	ampérage 20 ampères	fusibile / fusibile con capacity 20 Ampère	fusible / amperaje 20 amperes	Zekering / zekeringsterkte 20 Ampère
Zigarettenanzünder / Zubehör - Steckdose	cigarette lighter / accessory socket	allume-cigare / prise d'accessoires	accendisigari / presa accessori	encendido de cigarrillos / caja de accesorios	Sigarettenaansteker / accessoires stekkerdoos
Lautsprecher / Warnsummer	loudspeaker / buzzer	haut-parleur / vibreur	altoparlante / cicalino	altavoz / señal acústica de advertencia	Luidspreker / waarschuwingszoemer
Einparkhilfe	park distance control	assistance au parking	sensori di parcheggio	ayuda para aparcar	Inparkeerhulp
Schalter / Funktionsursprung	switch / source of function	interrupteur / origine de fonction	interruttore / origine funzione	interruptor / origen de función	Schakelaar / functieoorsprong
verbinden	Connect together	raccorder	connessione	conectar	Koppelen
trennen	disconnect	séparer	sconnessione	separar	Ontkoppelen
beachten / siehe weitere Informationen	Look at / see further information	considérer / voir informations ultérieures	considerare / vedere ulteriori informazioni	considerar / véase las informaciones	Let op / bekijk verdere informatie
beachte auserwählten Bereich	look carefully at selected area	faire attention à la zone sélectionnée	considerare area selezionata	considerar el área seleccionada	Let op gekozen bereik
vorhanden / belegt / i.o.	Present / Occupied / OK	disponible / occupé / OK	presente / occupato / OK	presente / ocupado / OK	Aanwezig / bezet / i.o.
nicht vorhanden / nicht belegt / nicht i.o.	Not present / Not occupied / not OK	pas disponible / pas occupé / pas OK	non presente / non occupato / non OK	non presente / non ocupado / non OK	Niet aanwezig / niet bezet / niet i.o.
links	left	gauche	sinistra	izquierdo	Links
rechts	right	droite	destra	derecho	Rechts
Akustische Signalisierung	acoustic indication	signalisation acoustique	segnalazione acustica	señalación acústica	Akoestische signalering
Achtung / wichtiger Hinweis	attention / important advice	attention / indication importante	attenzione / indicazione importante	atención / indicación importante	Attentie / belangrijke instructie