

**C3 Aircross**

11/17 →

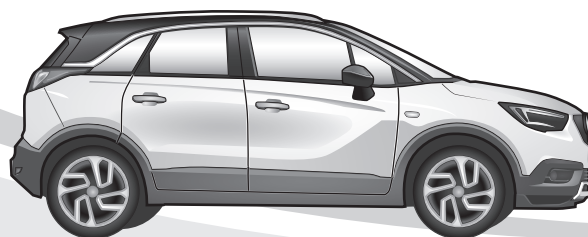

**Crossland X**

06/17 →



**Anhängerbetrieb konfigurieren / Set up trailer operation**



Die Beleuchtungsfunktionen am Anhänger funktionieren nur NACH Konfiguration des Fahrzeuges auf Anhängerbetrieb!

The light functions on the trailer will only operate AFTER the vehicle has been re-coded!

**D**

Einbauanleitung  
Elektro-Einbausatz für Anhängerkupplung / 7-polig / 12 Volt / ISO 1724

**GB**

Fitting instructions  
Electric wiring kit for towbars / 7-pin / 12 Volt / ISO 1724

**F**

Instructions de montage  
Faisceau pour attelage / 7 broches / 12 Volt / ISO 1724

**I**

Istruzione di montaggio  
Cablaggio elettrico per ganci di traino / 7 poli / 12 Volt / ISO 1724

**E**

Instrucciones de montaje  
Kits eléctricos para enganches de remolques / 7 pins / 12 Volt / ISO 1724

**NL**

Montagehandleiding  
Elektro-inbouwset voor aanhangerkoppeling / 7-polig / 12 Volt / ISO 1724



## WICHTIG!

**D**

### Vor Montagebeginn:

- Die aktuellen Herstellervorgaben beachten!
- Die Einbauanleitung komplett durchlesen und zwingend beachten!
- Dieses Produkt ist nur für linksgelenkte (LHD) Fahrzeuge geeignet!
- Bei Fremdverwendung oder Veränderung des Produktes erlischt jeglicher Anspruch auf Einbauunterstützung und Gewährleistung!

Änderungen bezüglich Konstruktion, Ausstattung, Farbe sowie Irrtum vorbehalten. Alle Angaben und Abbildungen sind unverbindlich. Der in Deutsch gehaltene Text in dieser Einbau-Anleitung ist bindend!

Für technische bzw. elektronische Änderungen, sowie Softwareupdates, welche nach erstmaliger Inbetriebnahme des Elektrosatzes vom Fahrzeughersteller durchgeführt werden und beispielsweise zu Fehlfunktionen der Anhängersteckdose oder deren Peripherie führen, übernehmen wir keinerlei Gewährleistung!

Je nach Art des im E-Satz verwendeten Anhängermoduls ist eine Interaktion mit dem Fahrzeugbordnetz nur eingeschränkt oder gar nicht möglich. Mit den spezifischen Diagnosesystemen der Fahrzeughersteller kann nicht auf modulinterne Fehlerspeicher zugegriffen werden.

Fehlerprotokolle in Bezug auf Anhängerbetrieb, die während eines Prüfprozesses mit den Diagnosesystemen der Fahrzeughersteller generiert werden, sind mitunter auf eine nicht ordnungsgemäße Freischaltung für Anhängerbetrieb zurückzuführen.

### Wir empfehlen

- die Auswertung der fahrzeugseitigen Fehlerspeicher sowie ggf. die Instandsetzung aller gelisteten Defekte vor Beginn aller Montagearbeiten!
- das Anhängermodul ggf. vom Leitungssatz zu trennen und den Diagnoseprozess noch einmal zu starten!
- die Fehlersuche bei Funktionsproblemen auf max. 0,5 Stunden zu begrenzen und sich danach an unsere Hotline zu wenden!



**HOTLINE +49 5246 921019**  
support@jaeger-automotive.de



## IMPORTANT!

**GB**

### Before starting the installation:

- Pay attention to the latest manufacturer's specifications!
- Read the complete installation instructions and follow these at all costs!
- This product is only designed for left-hand drive (LHD) vehicles!
- If the product is used for a different purpose or modified, any entitlement to support during the installation and the warranty will be forfeited!

Subject to changes with respect to design, equipment, colour and error. All of the data and illustrations are without obligation. The German text in these installation instructions is binding!

We can assume no warranty or guarantee for technical and electrical modifications or software updates carried out by the vehicle manufacturer following the initial commissioning of the electric kit and which, for example, may lead to malfunctions in the trailer socket or its peripheral equipment!

Depending on the type of trailer module used in the electric kit, interaction with the vehicle's electrical system may be limited or even impossible. The error memory inside the module cannot be accessed with the specific diagnostic system of the vehicle manufacturer.

Error logs relating to the trailer mode that are generated during a test process with the vehicle manufacturer's diagnostic system are sometimes due to an incorrect activation for the trailer mode.

### We recommend

- an analysis of the vehicle's error memory and possibly the repair of all listed faults before the start of the installation!
- possibly disconnecting the trailer module from the lead set and re-starting the diagnosis process!
- limiting troubleshooting in the event of malfunctions to a max. of 0.5 hours and then contacting our hotline!



**HOTLINE +49 5246 921019**  
support@jaeger-automotive.de



## IMPORTANT!

**F**

### Avant de commencer le montage:

- Respecter les consignes actuelles du constructeur!
- Lire la notice d'installation en entier et en tenir rigoureusement compte!
- Ce produit convient uniquement pour les véhicules avec conduite à gauche (LHD)!
- Tout autre usage ou modification du produit entraîne l'annulation de toute prétention à une assistance pour le montage ainsi qu'à la garantie!

Sous réserve de modifications sur le plan de la construction, de l'équipement, de la couleur ainsi que d'erreurs. Toutes les informations et illustrations sont fournies sans engagement. Le texte en allemand dans cette notice d'installation fait foi!

Nous déclinons toute responsabilité pour les modifications techniques ou électroniques, ainsi que pour les mises à jour logicielles réalisées après la mise en service initiale du kit électronique du constructeur du véhicule et pouvant provoquer par exemple des dysfonctionnements de la prise de courant de la remorque ou de sa périphérie!

Suivant le type de module de remorque utilisé dans le kit électronique, une interaction avec le réseau de bord du véhicule n'est pas possible ou ne l'est que dans certaines limites. Il est impossible d'accéder aux mémoires d'erreurs internes avec les systèmes de diagnostic spécifiques des constructeurs de véhicules.

Les procès-verbaux d'erreurs concernant le fonctionnement de la remorque qui ont été générés durant un processus de contrôle avec les systèmes de diagnostic des constructeurs de véhicules sont parfois attribuables à une activation non conforme pour le fonctionnement de la remorque.

### Nous recommandons

- d'analyser les mémoires d'erreurs du véhicule ainsi qu'éventuellement de réparer toutes les défaillances mentionnées avant le commencement de tous les travaux de montage!
- de séparer le module remorque le cas échéant du jeu de câbles et de remettre en marche encore une fois le processus de diagnostic!
- de limiter la recherche d'erreurs à 0,5 h maximum en cas de problèmes de fonctionnement et de s'adresser ensuite à notre hotline!



**HOTLINE +49 5246 921019**  
support@jaeger-automotive.de



## IMPORTANTE!

I



Prima dell'inizio del montaggio:

- Si prega di osservare tassativamente le indicazioni attuali del costruttore!
- Leggere integralmente e attenersi alle istruzioni di montaggio!
- Questo prodotto è adatto solo a veicoli con la guida a sinistra (LHD)!
- In caso di utilizzo scorretto o modifica del prodotto, decade ogni diritto di supporto al montaggio e di garanzia!

Con riserva di modifiche strutturali, di dotazione, colore ed errori. Tutti i dati e le figure non sono vincolanti. Il testo in tedesco in queste istruzioni di montaggio è vincolante!

Non concediamo alcuna garanzia per modifiche tecniche o elettroniche, aggiornamenti software che dopo la prima messa in funzione del gruppo elettronico vengono effettuate dal costruttore del veicolo e, ad esempio, possono causare malfunzionamenti della presa del rimorchio o delle sue periferiche!

A seconda del tipo di modulo rimorchio utilizzato nel gruppo elettronico, l'interazione con la rete di bordo del veicolo è possibile solo parzialmente o non è affatto possibile. Con i sistemi di diagnosi specifici dei costruttori di veicoli, non è possibile accedere alla memoria errori interna al modulo.

I protocolli di errore riferiti al funzionamento con rimorchio, generati durante un processo di collaudo con i sistemi di diagnosi dei costruttori di veicoli, sono da ricondurre, tra l'altro, a un'attivazione non corretta per funzionamento con rimorchio.

Consigliamo

- di effettuare assolutamente l'analisi della memoria errori sul veicolo ed eventualmente la riparazione di tutti i difetti riscontrati, prima di iniziare qualsiasi lavoro di montaggio;
- di scollegare eventualmente il modulo rimorchio dalla serie di cavi e di avviare nuovamente il processo di diagnosi;
- di limitare la ricerca errori in caso di problemi di funzionamento a max. 0,5 ore, quindi di rivolgersi al nostro numero verde.



**HOTLINE +49 5246 921019**  
support@jaeger-automotive.de



## ¡IMPORTANTE!

E



Antes de comenzar el montaje:

- ¡Observar las especificaciones actuales del fabricante!
- ¡Leer las instrucciones de montaje por completo y seguirlas sin falta!
- ¡Este producto solo es apto para vehículos con volante a la izquierda (LHD)!
- ¡El uso fuera de este ámbito o la modificación del producto supone la extinción de cualquier derecho de asistencia técnica para el montaje y garantía!

Queda reservado el derecho a realizar modificaciones constructivas, de equipamiento y color y de posibles errores. Todos los datos e ilustraciones se entienden sin compromiso. ¡La versión vinculante de estas instrucciones de montaje es la original en lengua alemana!

¡No asumiremos garantía alguna por modificaciones técnicas y/o electrónicas o actualizaciones de software que se lleven a cabo después de la primera puesta en servicio del kit eléctrico por parte del fabricante del vehículo y que puedan dar lugar, por ejemplo, a fallos de funcionamiento de la base eléctrica para el remolque o los periféricos!

En función del tipo de módulo para remolques CFC utilizado en el kit eléctrico no se podrá interactuar con el sistema eléctrico de a bordo o solo de forma limitada. Los sistemas de diagnóstico específicos de los fabricantes de vehículos no permiten el acceso a las memorias de fallos internas del módulo.

Los protocolos de fallos referidos al servicio con remolque, que se generen con sistemas de diagnóstico de los fabricantes de vehículos durante un proceso de inspección, a veces son el resultado de un desbloqueo incorrecto para el servicio con remolque.

Recomendamos:

- ¡evaluar las memorias de fallos del vehículo y eliminar, en caso dado, todos los defectos enumerados antes de comenzar los trabajos de montaje!
- ¡separar el módulo para remolques del juego de cables en caso dado y volver a iniciar el proceso de diagnóstico!
- ¡limitar la búsqueda de fallos en caso de problemas de funcionamiento a un máximo de 0,5 horas y acudir entonces a nuestra línea de atención!



**HOTLINE +49 5246 921019**  
support@jaeger-automotive.de



## BELANGRIJK!

NL



Voordat u begint te monteren:

- Raadpleegt u eerst de actuele richtlijnen van de producent!
- Leest u de instructies voor de installatie helemaal door en volg de aanwijzingen nauwgezet op!
- Dit product is alleen geschikt voor voertuigen met een stuur aan de linkerkant!
- Wanneer het product wordt gewijzigd of niet op correcte wijze wordt gebruikt, vervallen alle garanties en alle rechten op ondersteuning bij de inbouw.

Aan deze informatie en afbeeldingen kunnen geen rechten worden ontleend. Wijzigingen voorbehouden ten aanzien van constructie, uitrusting, kleur en/of eventuele misrekening/verginging. De Duitstalige tekst van deze gebruiksaanwijzing is bindend!

Wij dragen geen enkele aansprakelijkheid voor technische en/of elektronische wijzigingen alsmede software-updates die worden verricht na de eerste inbedrijfstelling van de elektrische set door de autofabrikant en die bijvoorbeeld leiden tot fouten in het functioneren van de aanhangerstekkerdoos en/of de randapparatuur!

Afhankelijk van de soort aanhangermodule die in de elektrische set wordt gebruikt, kan de interactie met het voertuignetwerk beperkt of zelfs onmogelijk zijn. Met de specifieke diagnostische systemen van de autofabrikant is geen toegang mogelijk tot foutenlogboeken die zich in de module zelf bevinden.

Foutrapportages ten aanzien van de werking van de aanhanger, die kunnen worden gegenereerd tijdens testprocedures door het diagnostische systeem van de autofabrikant, zijn soms te herleiden tot een incorrecte aansluiting en/of activering van het aanhangersysteem.

Wij raden u aan

- de foutrapportages van uw voertuig te inspecteren, en de nodige reparaties te verrichten, voor aanvang van elk montagewerk!
- uw aanhangermodule indien nodig los te koppelen van de kabelset, waarna u de diagnoseprocedure opnieuw opstart!
- in geval van functionele problemen niet langer dan een half uur te zoeken naar een fout, maar contact op te nemen met onze hotline!



**HOTLINE +49 5246 921019**  
support@jaeger-automotive.de

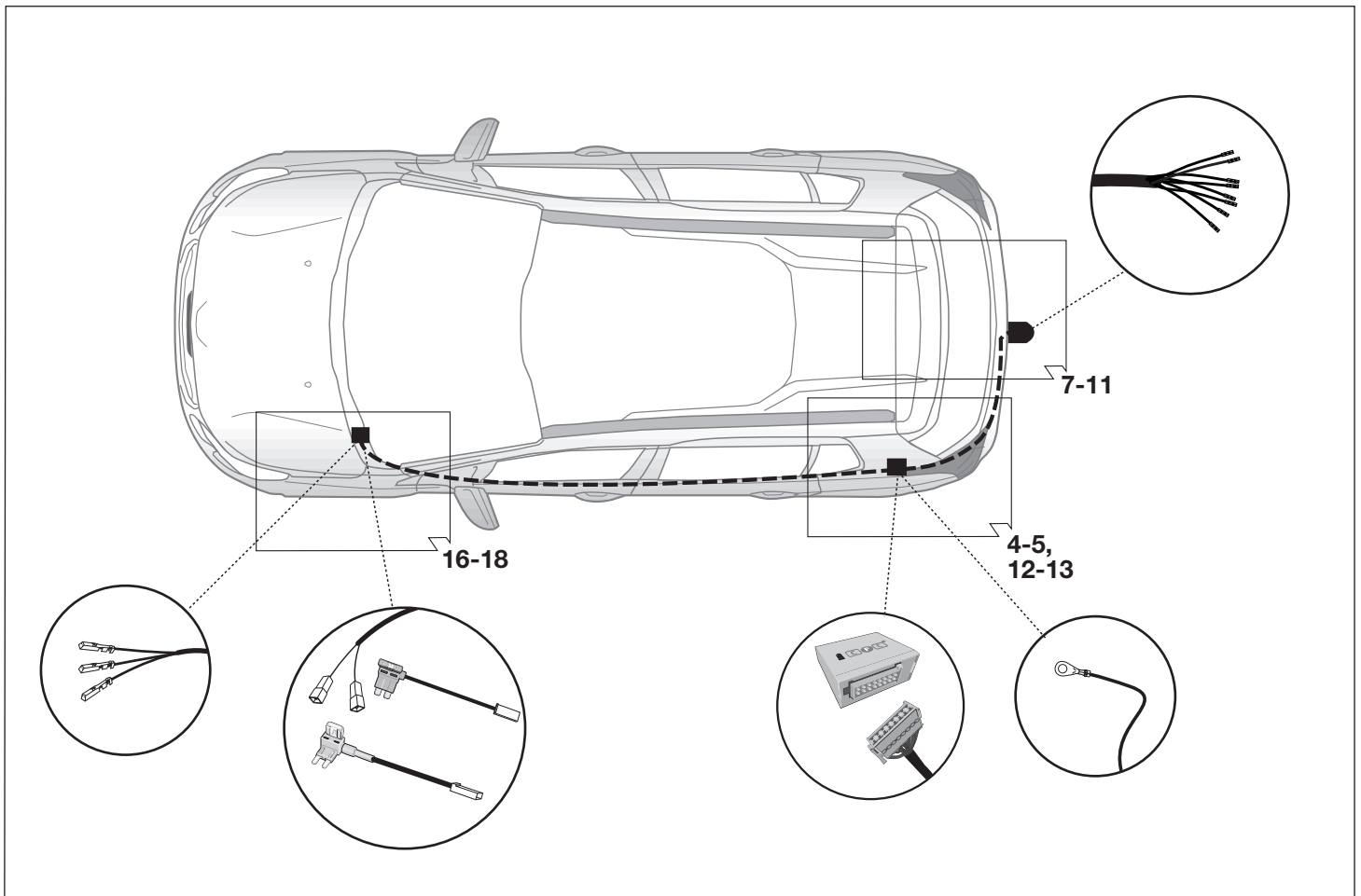
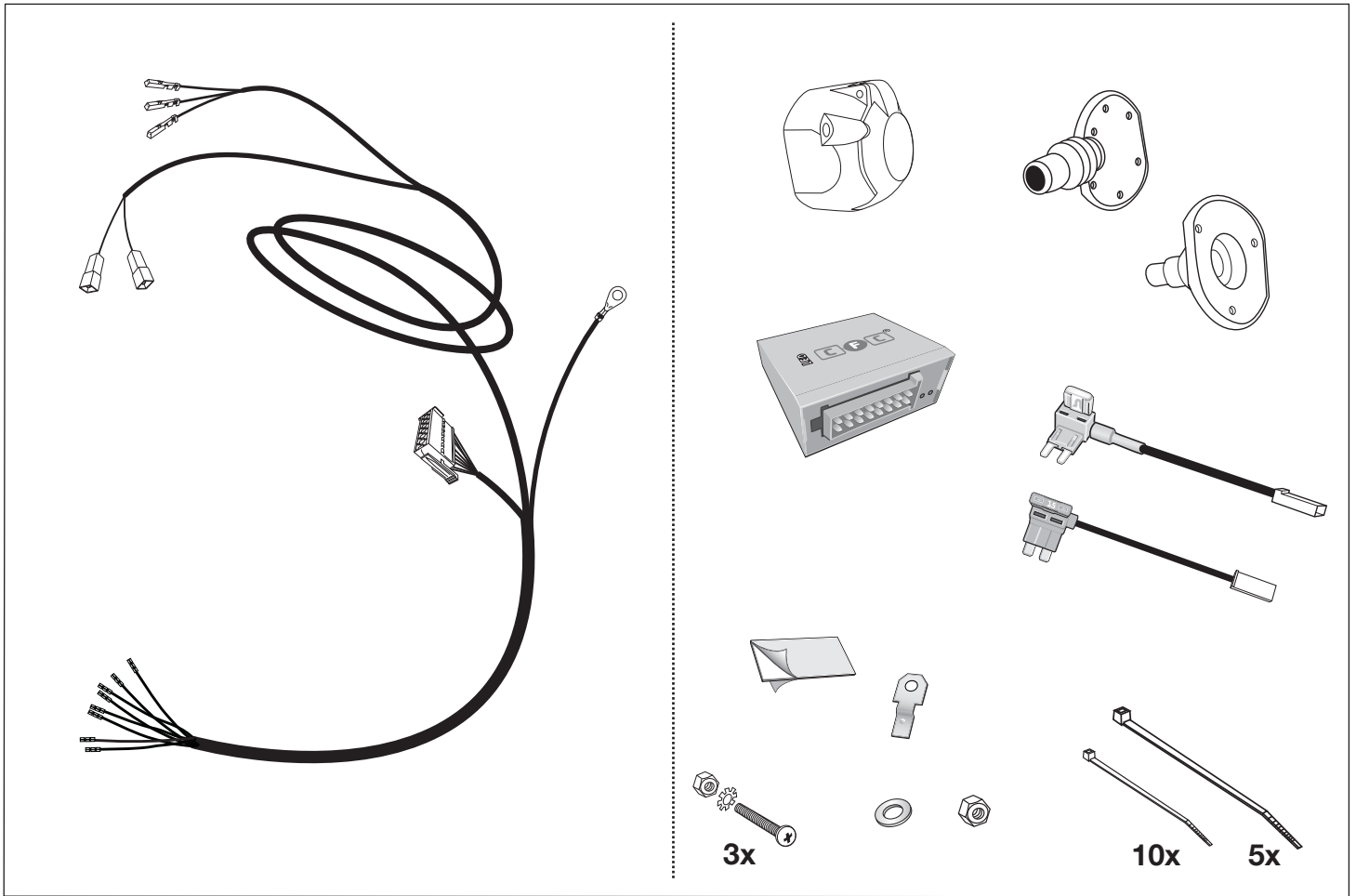

# Werkzeuge - Tools - Outils - Utensile - Herramientas - Werktuigen

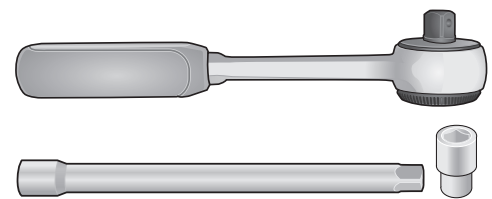
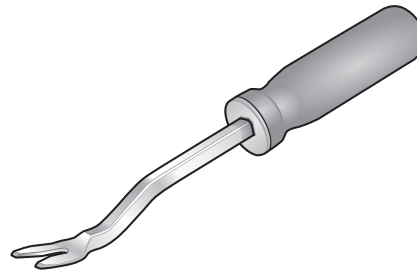
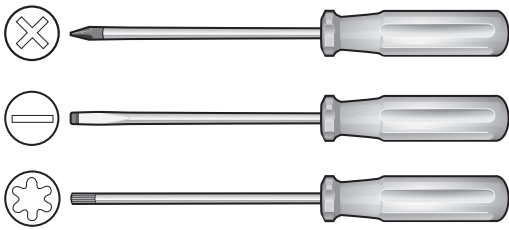

ACHTUNG!	ATTENTION!	ATTENTION!	ATTENZIONE!	¡ATENCIÓN!	ATTENTIE!
<b>(D)</b>	<b>(GB)</b>	<b>(F)</b>	<b>(I)</b>	<b>(E)</b>	<b>(NL)</b>
Die Kühlerleistung des Fahrzeuges muß bei Nachrüstung einer Anhängerkupplung möglicherweise erhöht werden! Bitte unbedingt Herstellerangaben beachten!!	The vehicle's cooling capacity may have to be increased when retrofitting a trailer coupling! You must observe the manufacturer's instructions!!	Il peut s'avérer nécessaire d'augmenter la puissance du radiateur du véhicule lorsque celui est équipé ultérieurement d'un attelage remorque! Respecter impérativement les instructions du constructeur!!	La capacità di raffreddamento del veicolo, quando si applica un gancio di traino, si deve possibilmente aumentare! Si prega di osservare tassativamente le indicazioni del produttore!!	¡Es posible que haya que aumentar la capacidad del radiador en caso de reequipar un acoplamiento de remolque! ¡Rogamos tener en cuenta las instrucciones de fabricante sin falta!	Het koelvermogen van het voertuig moet mogelijk worden verhoogd als achteraf een aanhangerkoppeling wordt aangebracht! Absoluut de fabrieksopgaven in acht nemen a.u.b.!!

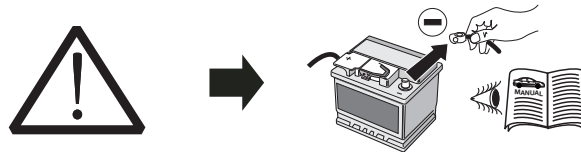

ACHTUNG!	ATTENTION!	ATTENTION!	ATTENZIONE!	¡ATENCIÓN!	ATTENTIE!
Um Störungen und Schäden am Bordnetz zu vermeiden, <b>muß</b> die Massepolklemme unbedingt <b>vor Beginn aller Arbeiten</b> von der Fahrzeugbatterie getrennt werden!  Insbesondere bei Arbeiten und Anschlüssen am CAN-Datenbus kann bei nicht abgeklemmter Batterie sowohl das Anhängermodul als auch das fahrzeugseitige Bordnetzsteuergerät beschädigt werden!  Bitte Herstellervorschriften beim Ab- und Anklemmen der Fahrzeugbatterie beachten!	In order to avoid malfunctions and damage to the vehicle's electrical system the earth terminal <b>must be disconnected</b> from the vehicle's battery <b>before starting work!</b>  Both the trailer module and the vehicle's control unit for the electrical system can be damaged during work on the CAN data bus connections if the battery is not disconnected!  Please pay attention to the manufacturer's instructions when disconnecting and reconnecting the vehicle's battery!	Afin d'éviter tout dysfonctionnement ou endommagement du circuit de bord, <b>il est indispensable</b> de débrancher la pince de masse de la batterie du véhicule <b>avant le début de toute opération!</b>  En particulier s'il s'agit de travaux et de branchements effectués sur le bus de données CAN, si la batterie n'est pas débranchée, le module remorque aussi bien que le dispositif de commande de circuit de bord du véhicule risquent d'être endommagés!  Veuillez respecter les directives du fabricant lors du branchement et du débranchement de la batterie du véhicule!	Per evitare disturbi e danni alla rete di distribuzione elettrica, l'espansione polare a massa <b>deve</b> essere assolutamente scollegata dalla batteria del veicolo <b>prima dell'inizio dei lavori!</b>  In particolare durante i lavori e gli allacciamenti al bus di dati CAN, se la batteria non è scollegata si possono danneggiare sia la centralina rimorchio, sia la centralina della rete di distribuzione elettrica del veicolo!  Attenersi alle indicazioni del costruttore per scollegare e ricollegare la batteria del veicolo!	¡Para evitar fallos y defectos en el sistema eléctrico de a bordo <b>es imprescindible</b> separar al terminal de puesta a tierra de la batería del vehículo <b>antes de realizar cualquier trabajo!</b>  ¡Particularmente al realizar trabajos y conexiones al bus de datos CAN puede estropearse tanto el módulo para remolques como el regulador del sistema eléctrico de a bordo del vehículo si no se ha desconectado la batería!  ¡Rogamos observar las instrucciones del fabricante al conectar y desconectar la batería del vehículo!	Om storingen en schade aan de elektrische bedrading te vermijden <b>moet</b> de massapoolklem absoluut <b>vóór aanvang van alle werkzaamheden</b> worden losgekoppeld van de voertuigaccu!  Vooral bij werkzaamheden aan aansluitingen op de CAN-databus kan zowel de aanhangermodule als de voertuigzijdige regeleenheid voor de elektrische installatie beschadigd worden, als de accu niet ontkoppeld is!  Fabrieksvoorschriften bij het vast- en loskoppelen van de voertuigaccu in acht nemen a.u.b.!

Citroën C3 Aircross

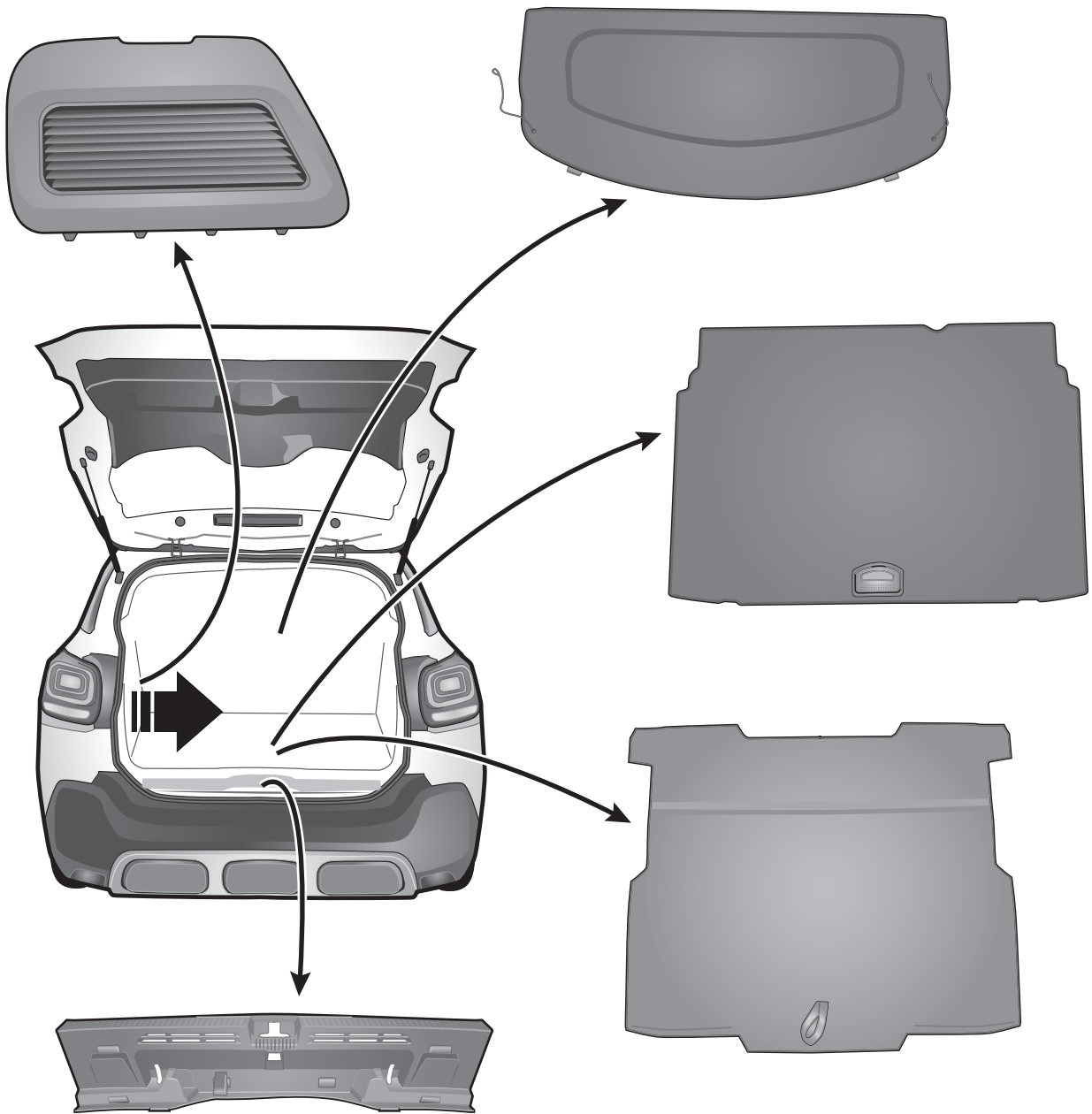

2

Opel Crossland X

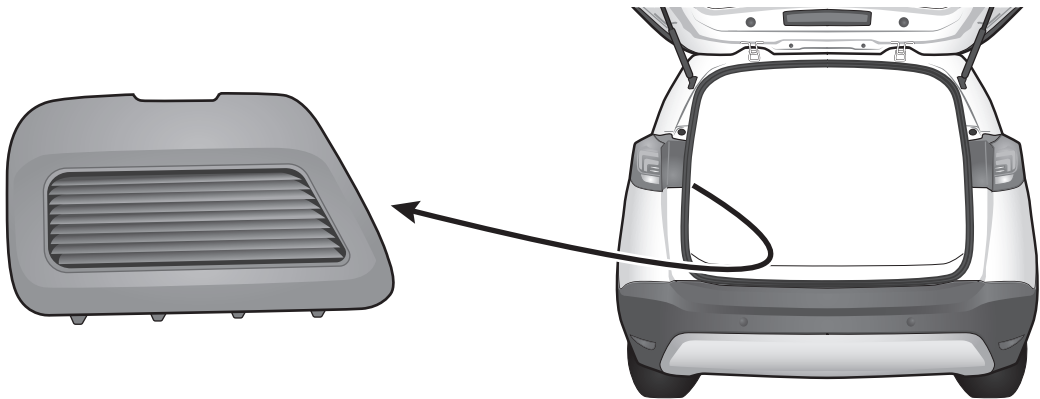

3

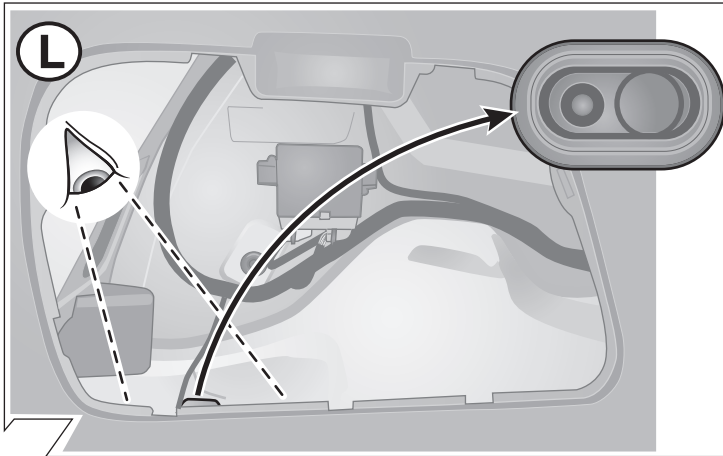

4

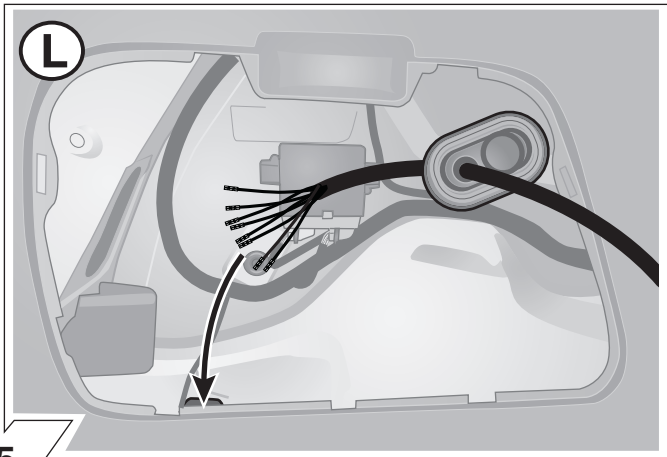
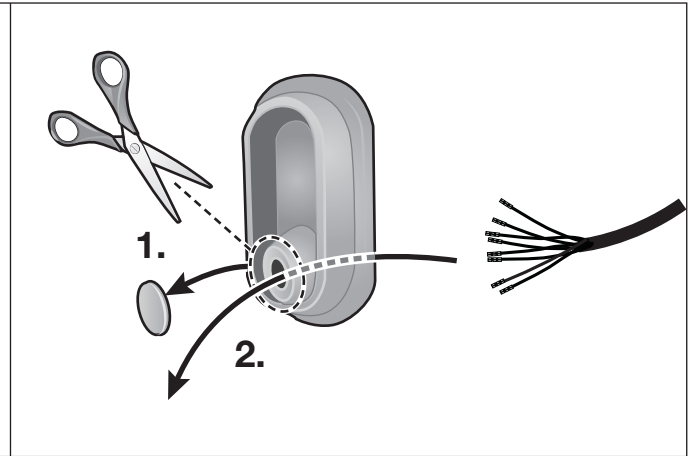

5

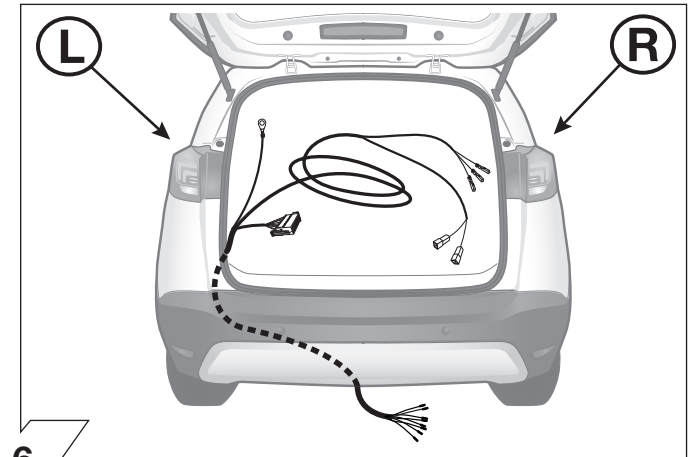

6

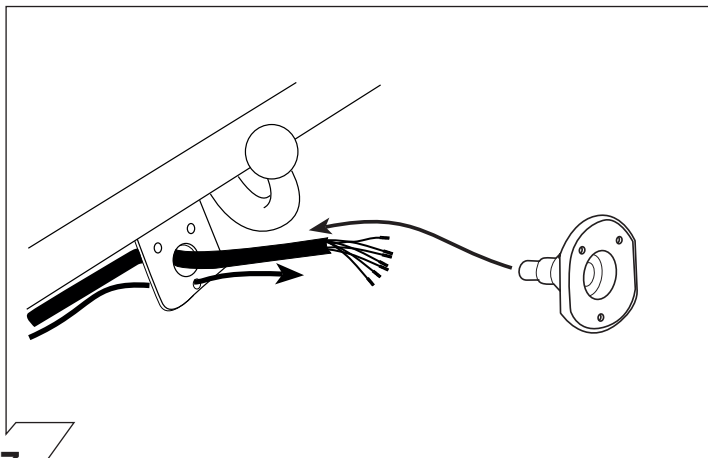

7

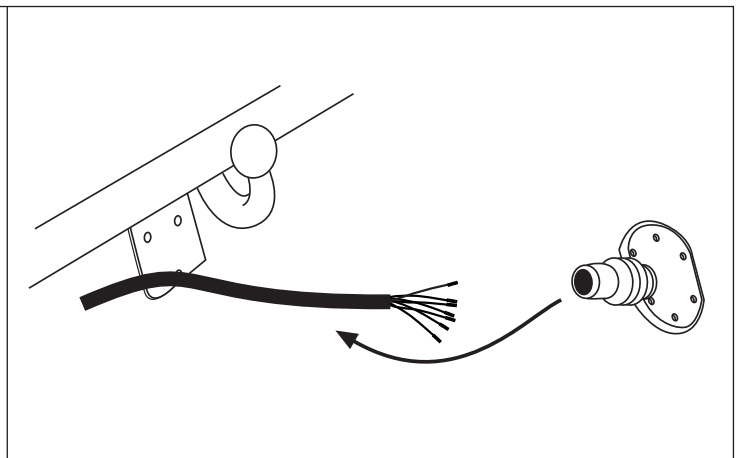

ISO 1724	Belegung der Steckdose / Maximale Ausgangsleistung Socket configuration / Maximum power output Correspondance des contacts de la prise / Puissance de sortie maximale Abbinamento della presa / Uscita di alimentazione massima Indeling van de stekkerdoos / maximaal uitgangsvermogen			
	1/L	BK/WT	21W	
	2	WT	42W	
	3/31	BR		
	4/R	BK/GN	21W	
	5/58-R	GY/RD	52W	
	6/54	BK/RD	63W	
	7/58-L	GY/BK	52W	

8

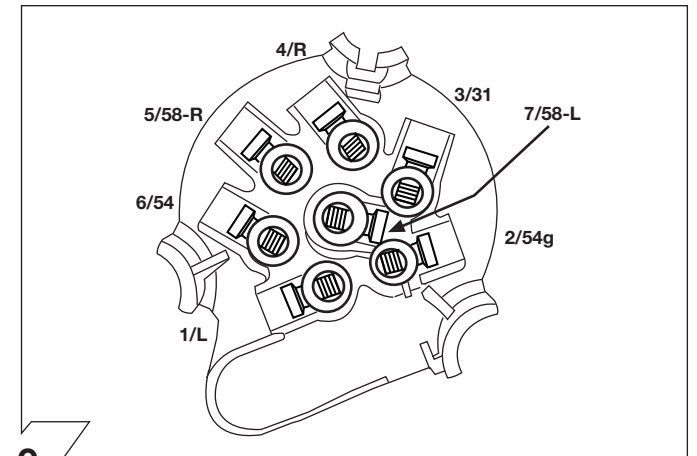

9

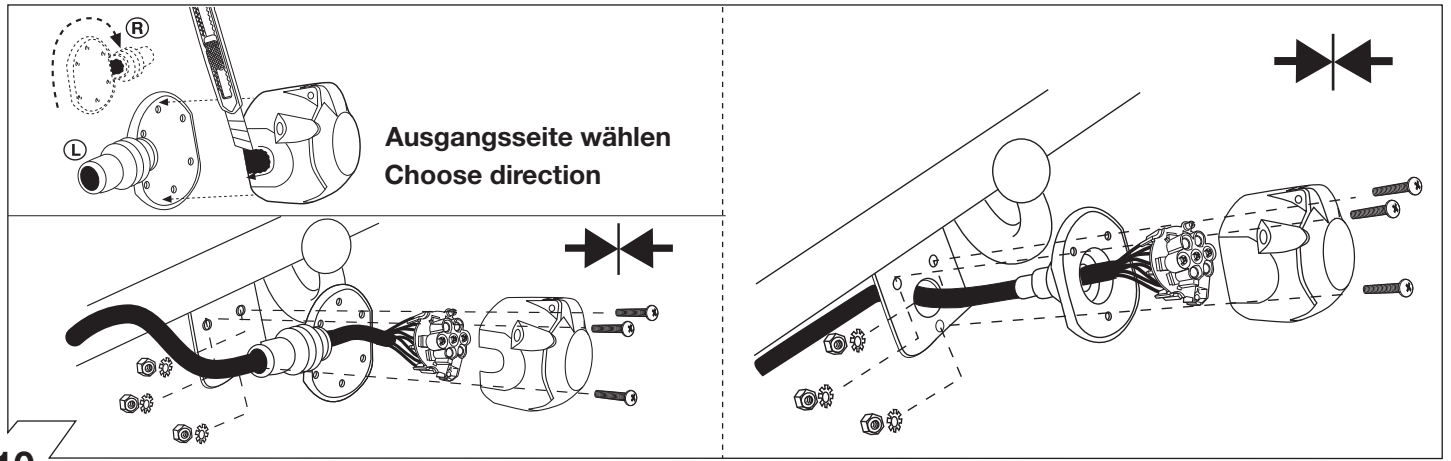

10

	(GB)	(D)	(E)	(F)	(I)	(P)	(NL)	(DK)	(N)	(S)	(FIN)	(CZ)	(H)	(PL)
<b>BK</b>	Black	Schwarz	Negro	Noir	Nero	Preto	Zwart	Sort	Svart	Svart	Musta	Černá	Fekete	Czarny
<b>RD</b>	Red	Rot	Rojo	Rouge	Rosso	Vermelho	Rood	Rød	Rød	Röd	Punainen	Červená	Piros	Czerwony
<b>GN</b>	Green	Grün	Verde	Vert	Verde	Verde	Groen	Grøn	Grønt	Grön	Vihreä	Zelená	Zöld	Zielony
<b>OR</b>	Orange	Orange	Naranja	Orange	Arancione	Laranja	Oranje	Orange	Orange	Orange	Oranssi	Oranzová	Narancs	Pomarańczowy
<b>VT</b>	Violet	Violett	Violeta	Violet	Viola	Violeta	Violet	Violet	Fiolet	Violet	Violetti	Fialová	Ibolya	Fioletowy
<b>PK</b>	Pink	Pink	Pink	Rose	Rosa	Cor-de-Rosa	Paars	Pink	Pink	Rosa	Pinkki	Růžová	Rózsaszín	Różowy
<b>BL</b>	Blue	Blau	Azul	Bleu	Blu	Azul	Blauw	Blå	Blått	Blå	Sininen	Modrá	Kék	Niebieski
<b>YL</b>	Yellow	Gelb	Amarillo	Jaune	Giallo	Amarelo	Geel	Gul	Gult	Gul	Keltainen	Zlutá	Sárga	Żółty
<b>WT</b>	White	Weiss	Blanco	Blanc	Bianco	Branco	Wit	Hvid	Hvitt	Vit	Valkoinen	Bílá	Fehér	Biały
<b>BR</b>	Brown	Braun	Marrón	Brun	Marrone	Marrom	Bruin	Brun	Brunt	Brun	Ruskea	Hnědá	Barna	Brazowy
<b>GY</b>	Grey	Grau	Gris	Gris	Grigio	Cinzeno	Grijs	Grå	Grått	Grå	Harmaa	Sedá	Szürke	Szary

11

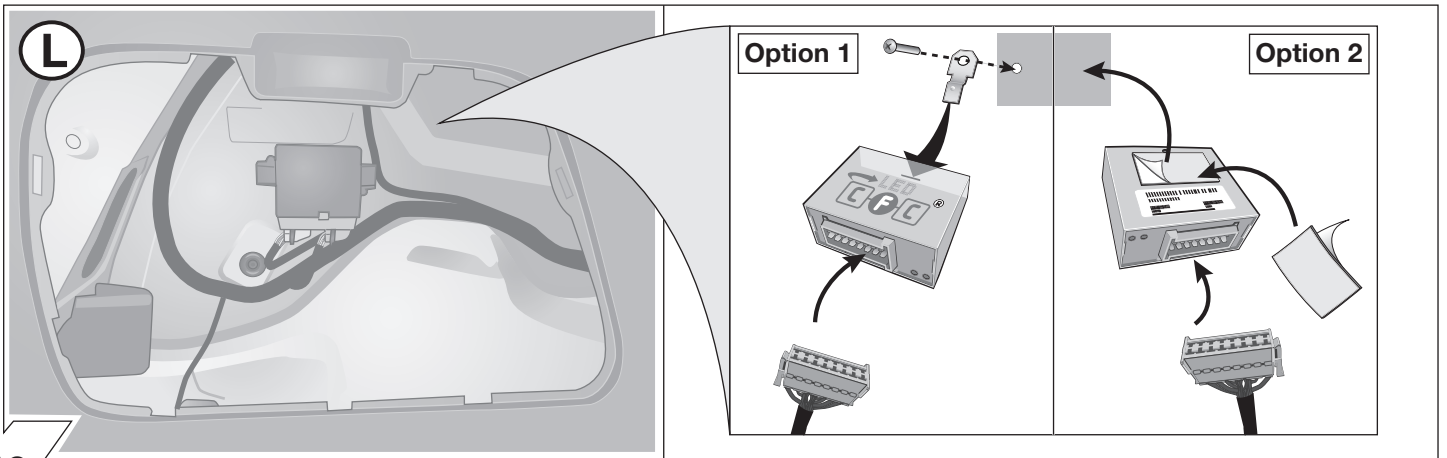

12

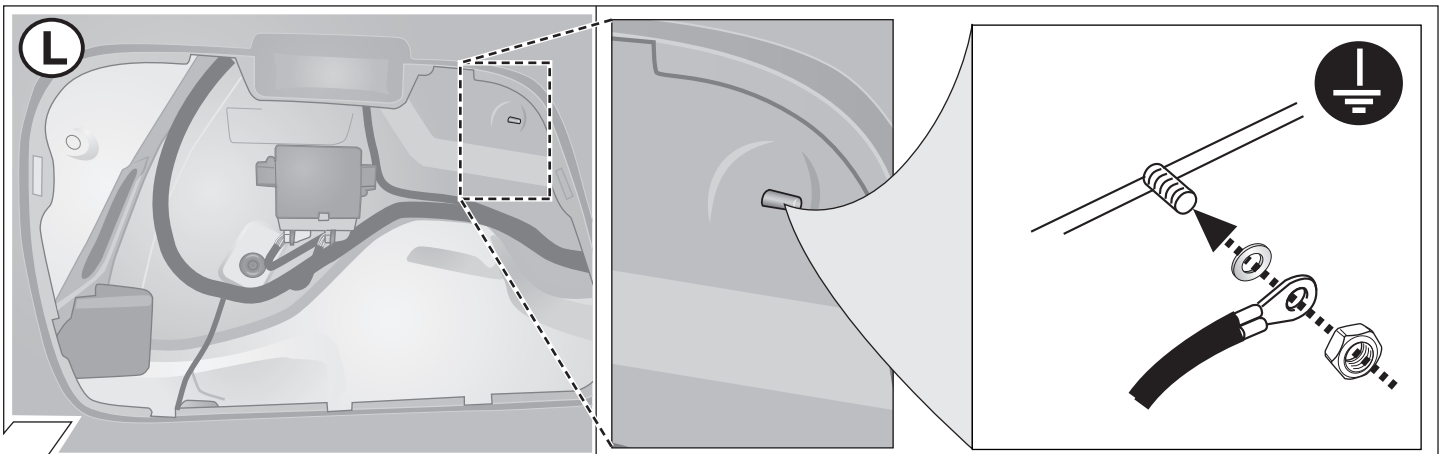

13



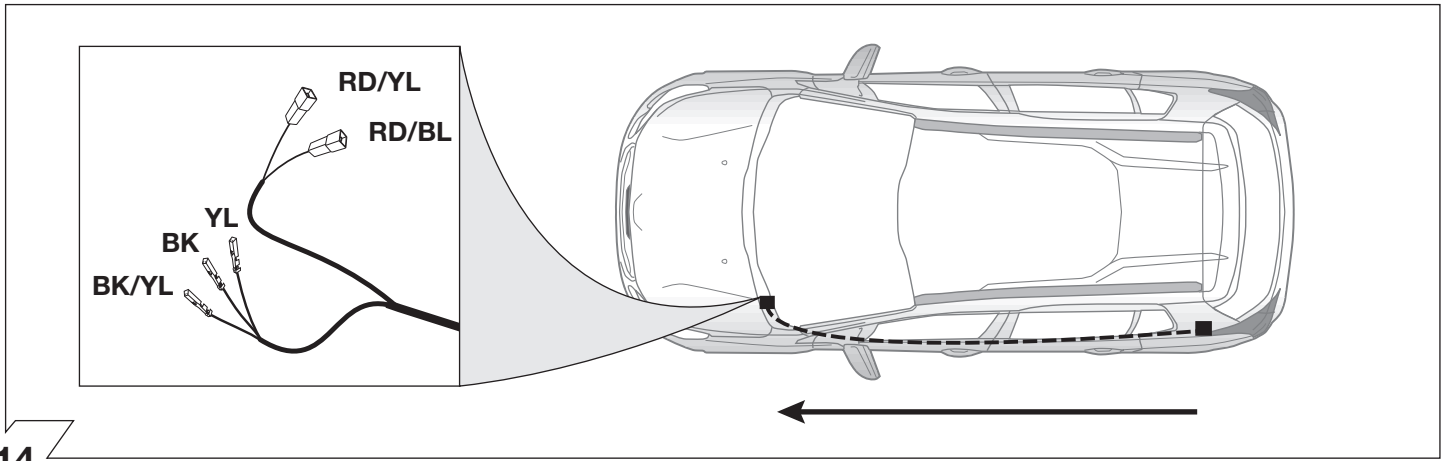

14

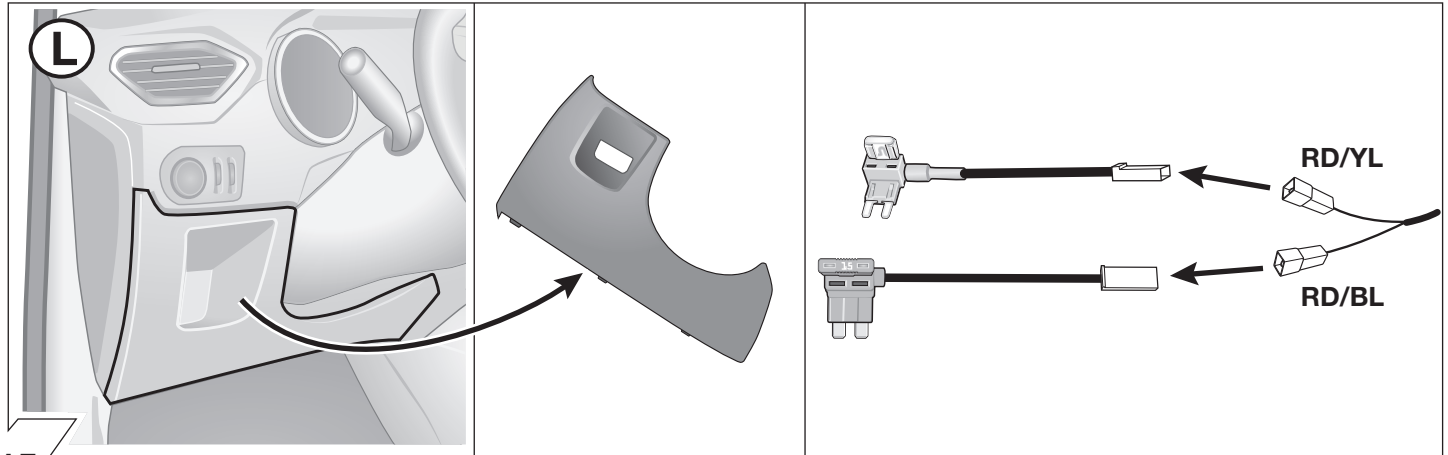

15

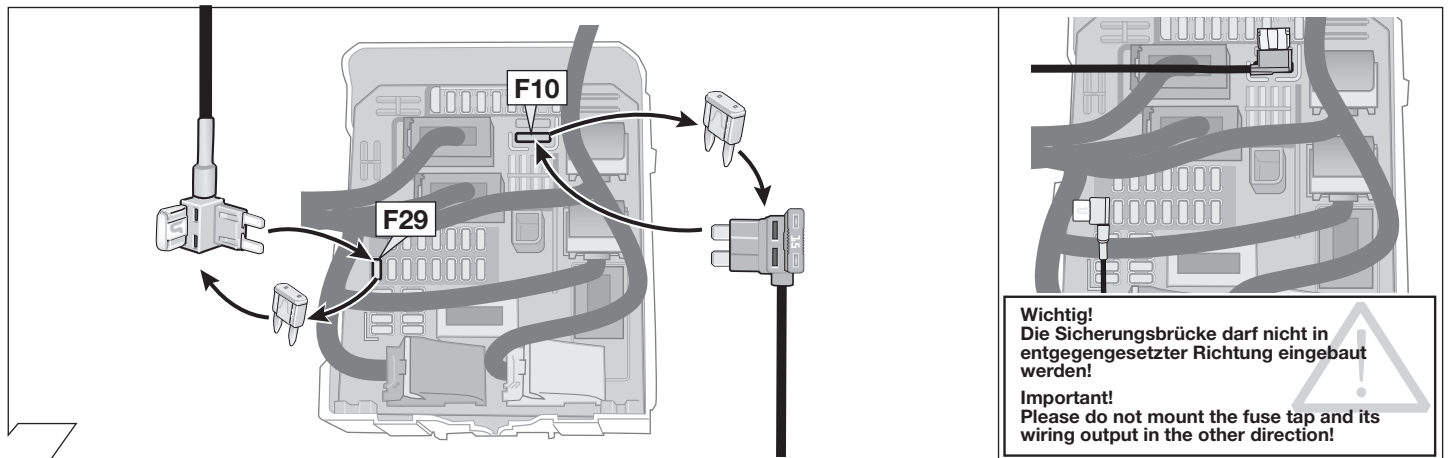

16

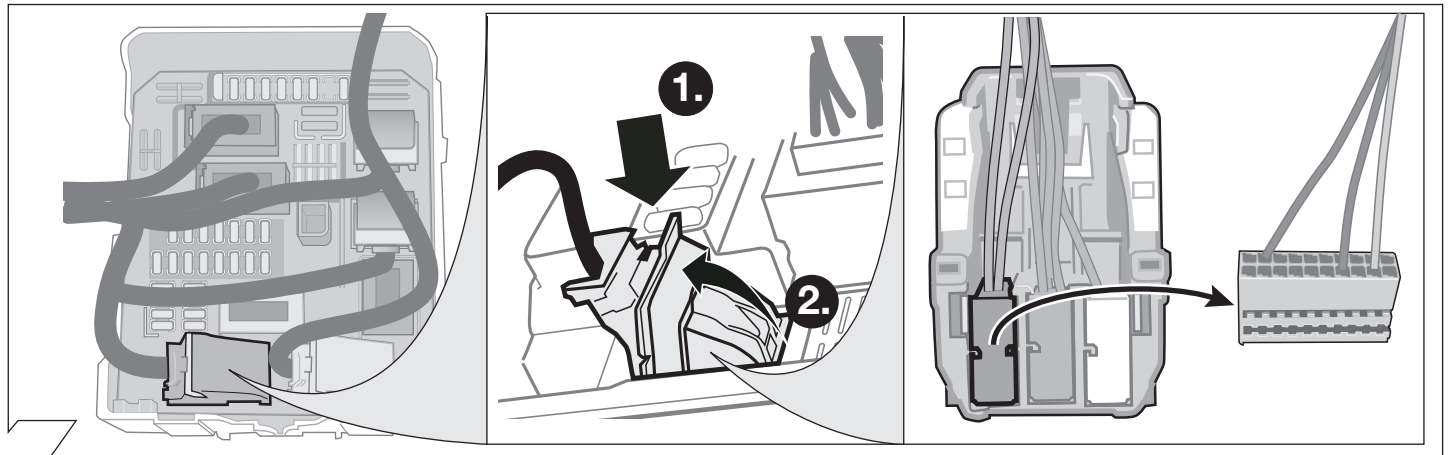

17

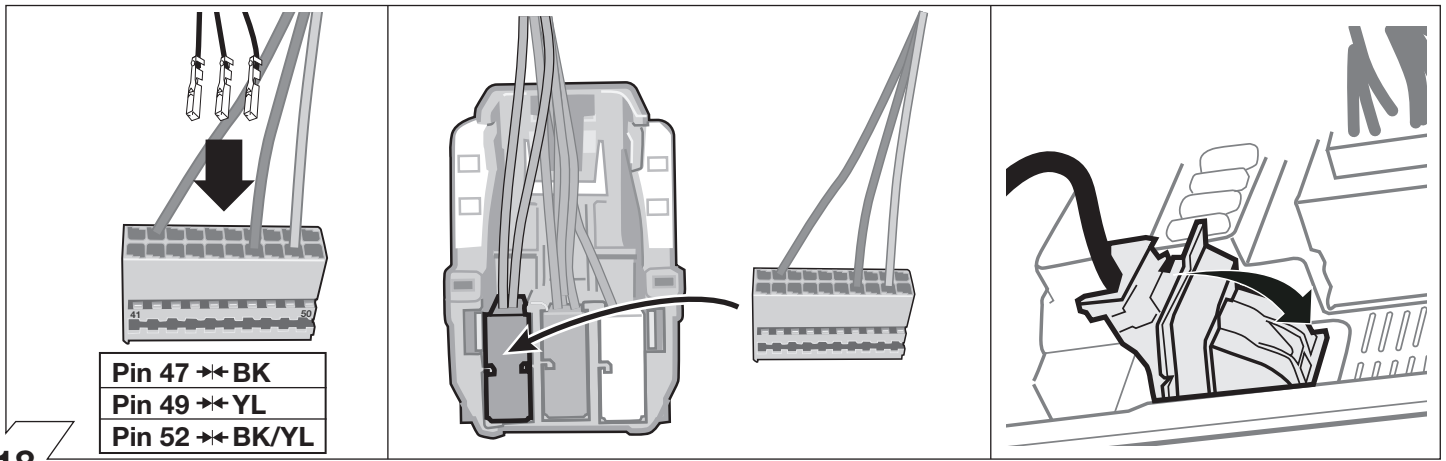





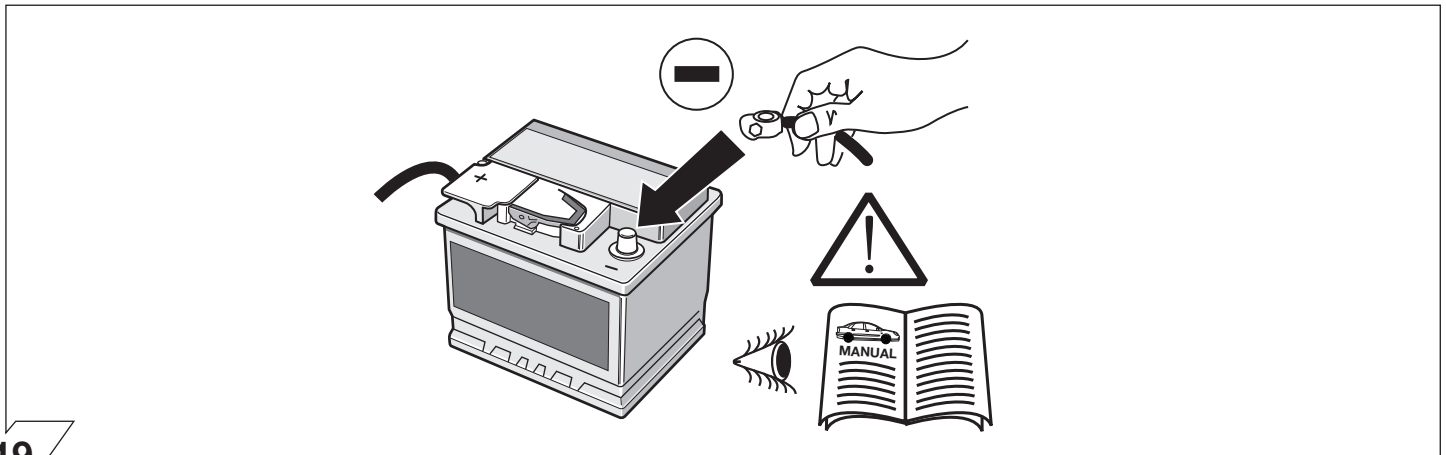

Pin 47 \*\* BK  
 Pin 49 \*\* YL  
 Pin 52 \*\* BK/YL

18



19

 <p>Folgende Beleuchtungsfunktionen des Anhängers werden <b>nicht</b> bei allen Zugfahrzeugen mit <b>Tagesfahrlichtschaltung</b> unterstützt:</p> <ul style="list-style-type: none"> <li>• Schlussleuchten</li> <li>• Begrenzungsleuchten</li> <li>• Kennzeichenbeleuchtung</li> </ul> <p>Zur Aktivierung dieser Funktionen muss <b>Stand- oder Abblendlicht eingeschaltet</b> werden!</p>	 <p>Le seguenti funzioni per l'illuminazione del rimorchio <b>non sono supportate</b> da tutte le motrici <b>con circuito di luci diurne</b>:</p> <ul style="list-style-type: none"> <li>• luci posteriori</li> <li>• luci d'ingombro</li> <li>• illuminazione targa</li> </ul> <p>Per attivare queste funzioni devono essere accese <b>le luci di posizione o gli anabbaglianti!</b></p>
 <p>The following light functions for the trailer are <b>not supported</b> by all towing vehicles with <b>DRL circuit</b>:</p> <ul style="list-style-type: none"> <li>• Rear lights</li> <li>• Side lights</li> <li>• Numberplate lights</li> </ul> <p>The <b>taillights or dimmed headlights must be switched on</b> to activate this function!</p>	 <p>De volgende verlichtingsfuncties van de aanhanger worden <b>niet</b> bij alle trekkende voertuigen <b>met daglichtschakeling</b> ondersteund:</p> <ul style="list-style-type: none"> <li>• Achterlichten</li> <li>• Spatbordlampen</li> <li>• Kentekenverlichting</li> </ul> <p>Ter activering van deze functies moet <b>parkeer- of dimlicht</b> worden ingeschakeld!</p>
 <p>Les fonctions d'éclairage suivantes de la remorque <b>ne sont pas activables</b> sur tous les véhicules de traction équipés de feux de circulation de jour:</p> <ul style="list-style-type: none"> <li>• Feux arrières</li> <li>• Feux d'encombrement</li> <li>• Éclairage de la plaque minéralogique</li> </ul> <p>Pour activer ces fonctions, <b>les feux de position ou de croisement</b> doivent être allumés!</p>	 <p>No todos los vehículos tractores <b>con conmutación de luz de marcha diurna</b> ofrecen un soporte para las siguientes funciones de iluminación del remolque:</p> <ul style="list-style-type: none"> <li>• Luces traseras</li> <li>• Luces de galibo</li> <li>• Iluminación de la matrícula</li> </ul> <p>¡Para activar estas funciones deberán encenderse <b>las luces de posición o las luces de cruce!</b></p>

20

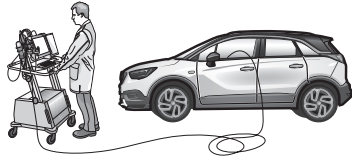

Codierung Steuergerät  
Code Control unit  
Codage dispositif de commande  
Codifica dispositivo di controllo  
Bedieningsapparaat coderen  
Contralor de codificacion

Seite 13  
page 13  
pagina 13  
pagina 13

21

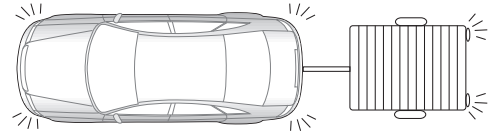
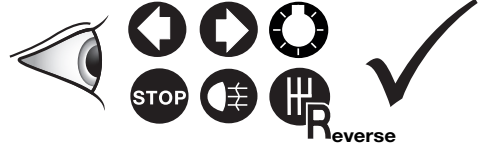

22

### PARK ASSIST-SYSTEM

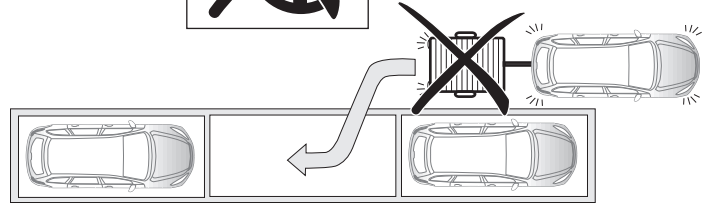
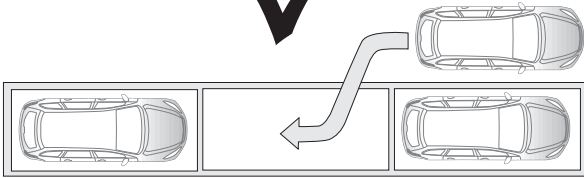

23

### OPTIONAL

Trailer Simulator  
for 7- and 13-pin  
Sockets

Part-no.  
50400521

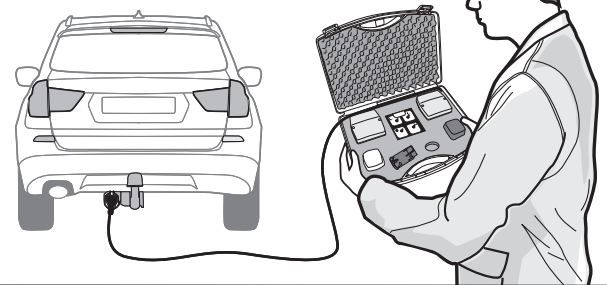
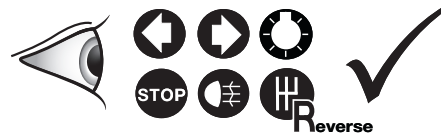

24

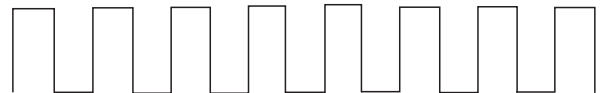
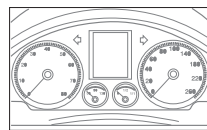
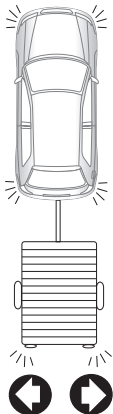

LED



25



**26**



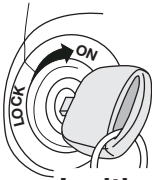

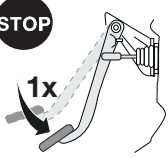
**SETUP**

1. 

2.  Ignition ON

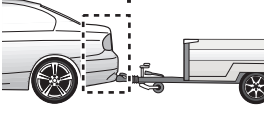

3.  STOP 1x

4.   

**27**

Optional: Adapter socket 62400001

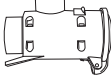

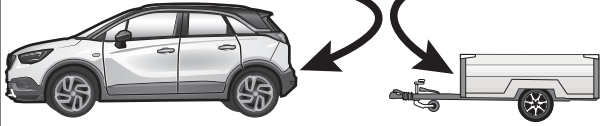

7-pin  13-pin 

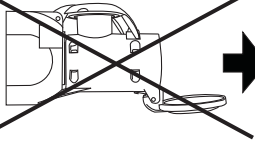
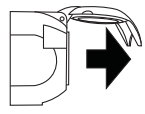
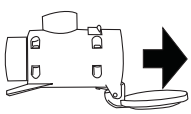

**28**

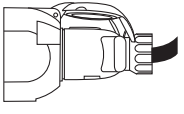
  
  
  
 ✓

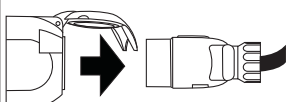
**29**

**30**

## Opel Crossland Anhängerbetrieb konfigurieren / Set up trailer operation

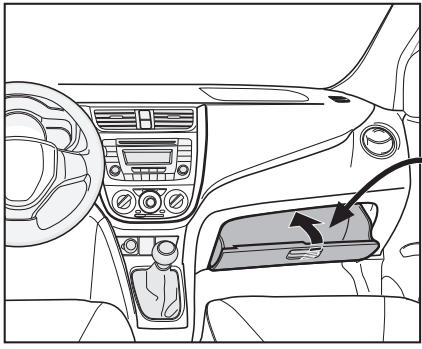
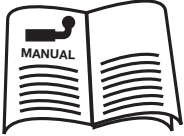

31

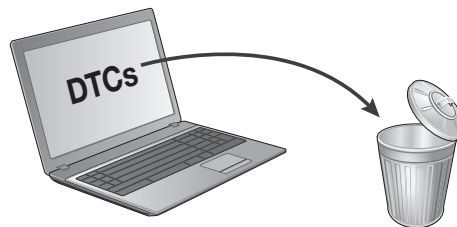
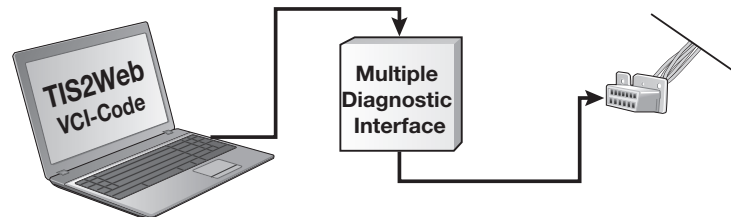
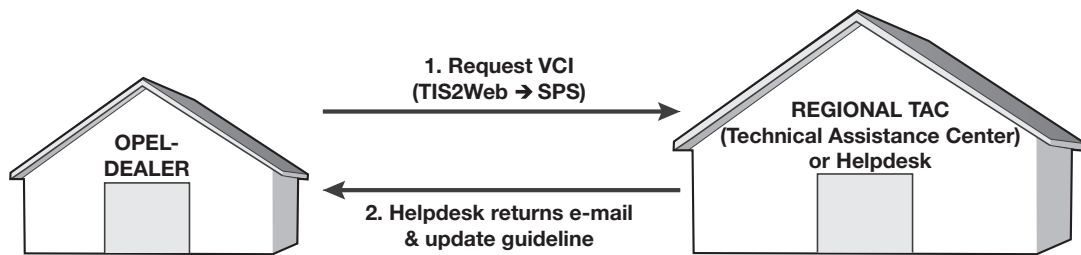
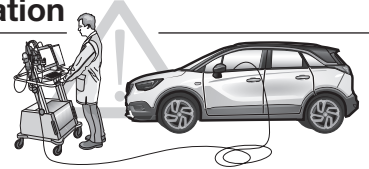
## Citroën C3 Aircross Anhängerbetrieb konfigurieren / Set up trailer operation



**D**

Die Aktivierung der Anhängerfunktionen muss mit Hilfe des **CITROËN Lexia-Testers** wie folgt durchgeführt werden:

- Fahrzeug auswählen
- Auslieferung
- Ausstattungen
- Schalteinheit Anhänger (BSR)
- Installation einer Ausstattung

**GB**

The activation of the trailer functions has to be carried out using the **CITROËN Lexia tester** as follows:

- choose vehicle
- delivery
- equipment
- trailer control unit (BSR)
- installation of equipment

**F**

L'activation des fonctions de la remorque doit être effectuée comme suit à l'aide du **testeur Lexia CITROËN**:

- choisir des véhicules
- livraison
- équipements
- partie commutation - remorque (BSR)
- installation d'un équipement

**I**

L'attivazione di rimorchio funzioni si deve eseguire con l'aiuto del **tester CITROËN Lexia** come segue:

- Scegliere veicolo
- I tempi di consegna
- Attrezzature
- Centralina rimorchio (BSR)
- L'installazione di apparecchiature

**E**

La activación del funciones de remolque deberá llevarse a cabo con ayuda del **comprobador Lexia de CITROËN** de la siguiente manera:

- elegir vehículo
- entrega
- equipo
- unidad de conmutación - remolque (BSR)
- instalación de equipos

**NL**

De activering van de trailer-functies moet met behulp van de **CITROËN Lexia-tester** als volgt worden uitgevoerd:

- Kies het voertuig
- Levering
- Apparatuur
- Schakelunit aanhanger (BSR)
- Installatie van apparatuur

32

<b>D</b> Diagnosefunktion der Kontroll-LED's	<b>GB</b> Diagnosis function of control LEDs	<b>F</b> Fonction diagnostic des LED de contrôle
<b>I</b> Funzione di diagnostica dei LED di controllo	<b>E</b> Función de diagnóstico de los LEDs de control	<b>NL</b> Diagnosefunctie van de controle-LED's
<p><b>Ignition OFF</b> → <b>No CAN-Data</b> = Standby / Sleepmode ✓</p>		
<p><b>Ignition ON</b> → GN ✓</p>		
<p><b>Ignition ON</b> → GN ✓</p>		
<p style="text-align: right;"><b>CAN-Data Wire PIN 13+14</b></p> <p><b>Ignition ON</b> → RD</p> <p style="text-align: center;">oder or</p> <p style="text-align: center;"><b>⚡/31: PIN 1</b></p> <p><b>Ignition ON</b> → RD</p>		
<p><b>Ignition ON</b> → RD</p> <p style="text-align: center;"><b>B+/30: PIN 2 oder/or 4</b></p>		
<p><b>D</b> Blinküberwachung und Leuchten-Substitution bei Ausfall der Anhänger-Blinkleuchten</p> <p>Der Ausfall von einer oder von beiden Anhänger-Blinkleuchten wird je nach Fahrzeugtyp und Ausführung des verbauten Elektro-Einbausatzes wie folgt angezeigt:</p> <ul style="list-style-type: none"> <li>• Erhöhung / Verdoppelung der Blinkfrequenz</li> <li>• Volltextmeldung im Display / Kombi-Instrument</li> <li>• Aktivierung Kontrollleuchte für Lampenausfall</li> <li>• Akustische Warnung via Buzzer oder Voice-Message</li> </ul> <p>Bei einem Blinkleuchten-Ausfall ersetzt die gleichseitige Rückleuchte durch Aufleuchten in der Blinkfrequenz eine defekte Anhänger-Blinkleuchte (► Leuchten-Substitution!).</p>	<p><b>GB</b> Indicator failure detection and lamp substitution if the trailer indicators fail</p> <p>The failure of a single or on both trailer indicators will be shown depending on the type of vehicle and electric kit installed as follows:</p> <ul style="list-style-type: none"> <li>• Increase in the flashing frequency</li> <li>• Text message in the Display / combi-instrument</li> <li>• Activated control lamp for light failure</li> <li>• Audible warning via Buzzer or Voice-Message</li> </ul> <p>If an indicator fails the left or right rear light compensates the faulty indicator by flashing at the correct frequency! (► lamp substitution).</p>	
<p><b>F</b> Surveillance des clignotants et substitution des feux en cas de panne des clignotants de la remorque</p> <p>La panne d'un ou des deux clignotants de la remorque est indiquée de la façon suivante en fonction du type de véhicule et du modèle de module électrique monté:</p> <ul style="list-style-type: none"> <li>• Augmentation / doublement de la fréquence de clignotement</li> <li>• Message complet sur l'affichage / l'instrument combiné</li> <li>• Activation du voyant de contrôle pour panne de lampe</li> <li>• Avertissement sonore via buzzer ou message vocal</li> </ul> <p>En cas de panne du clignotant, le feu arrière du côté de la panne remplace un clignotant de remorque défectueux en s'allumant à la même fréquence que le clignotant! (► Substitution des feux!).</p>	<p><b>I</b> Controllo delle frecce e sostituzione delle lampade in caso di guasto alle frecce del rimorchio</p> <p>A seconda del tipo di veicolo e della versione del kit elettrico montato, il guasto di una o di entrambe le frecce del rimorchio si manifesta come segue:</p> <ul style="list-style-type: none"> <li>• Aumento/raddoppio della frequenza di lampeggiamento</li> <li>• Full text display / strumento combinato</li> <li>• Attivazione della spia di controllo per il guasto lampada</li> <li>• Segnalazione acustica mediante cicalino o messaggio vocale</li> </ul> <p>In caso di guasto alla luce della freccia, la luce posteriore dello stesso lato si accende sostituendo nella frequenza del lampeggio la freccia difettosa del rimorchio. (► Sostituzione delle lampade!).</p>	
<p><b>E</b> Control de intermitentes y sustitución de lámparas en caso de fallo de los intermitentes del remolque</p> <p>El fallo de uno o de ambos intermitentes del remolque se indicará de la siguiente manera en función del tipo del vehículo y de la ejecución del juego de montaje eléctrico montado:</p> <ul style="list-style-type: none"> <li>• Aumento/duplicación de la frecuencia de parpadeo</li> <li>• Mensaje de texto completo en el display/instrumento combinado</li> <li>• Activación de la lámpara piloto para el fallo de lámparas</li> <li>• Advertencia acústica mediante zumbador o mensaje de voz</li> </ul> <p>Si hay un fallo de intermitente, la luz trasera del mismo lado reemplazará la lámpara defectuosa del intermitente parpadeando en la misma frecuencia que el intermitente (► Sustitución de lámparas!).</p>	<p><b>NL</b> Knippercontrole en lampvervanging bij uitval van de knipperlampen van een aanhangwagen</p> <p>De uitval van één of beide knipperlampen van een aanhangwagen wordt afhankelijk van het voertuigtype en de uitvoering van de ingebouwde elektroset als volgt aangegeven:</p> <ul style="list-style-type: none"> <li>• Verhoging / verdubbeling van de knipperfrequentie</li> <li>• Volledige tekstweergave op het display / combi-instrument</li> <li>• Activering controlelampje voor uitval van een lamp</li> <li>• Akoestische waarschuwing via buzzer of Voice-Message</li> </ul> <p>Bij een uitval van (een) knipperlamp(en) vervangt het gelijkzijdige achterlicht door aan te flitsen bij de knipperfrequentie een defecte knipperlamp van een aanhangwagen (► Lampvervanging!).</p>	

ERKLÄRUNG SYMBOLE	SYMBOL EXPLANATION	EXPLICATION DES SYMBOLES	SPIEGAZIONE DEI SIMBOLI	EXPLICACIÓN DE LOS SIMBOLES	VERKLARING SYMBOLEN
(D)	(GB)	(F)	(I)	(E)	(NL)
	left (58-L) respectively right (58-R) tail light	feu arrière gauche (58-L) respectivement droite (58-R)	luce posteriore sinistra (58-L) rispettivamente destra (58-R)	pilato trasero izquierdo (58-L) respectivamente derecho (58-R)	Linker (58-L) c.q. rechter (58-R) achterlicht
	stop light (54) / high mounted, third stop light (54)	3ième feu de stop (54) / feu de stop (54)	3. luce d'arresto (54)	tercera luz de freno (54)	Remlicht (54) / 3e remlicht (54)
	turn signal indicator left	feu indicateur de direction gauche	indicatore di direzione sinistra	luz indicadora de dirección de marcha izquierda	Richtingaanwijzer links
	turn signal indicator right	feu indicateur de direction droite	indicatore di direzione destra	luz indicadora de dirección de marcha derecha	Richtingaanwijzer rechts
	rear fog light(s)	feu (x) arrière (s) de brouillard	fendinebbia	luz (-ces) trasera (s) antineblia (s)	Mistachterlicht(en)
	reversing light(s)	feu (x) de marche arrière	luce (f) retromarcia	luz (-ces) de marcha atrás	Achteruitrijlicht(en)
	Permanent power supply / 13pin socket, chamber 9	courant continue / prise de courant à 13 pôles, compartiment 9	alimentazione continua / presa 13 poli, camera 9	positivo continuo / caja de anclufe a 13 polos, cámara 9	Continuustroom / stekkerdoos 13P kamer 9
	charging wire for trailer battery / 13pin socket, chamber 10	cable de charge / prise de courant à 13 pôles, compartiment 10	cavo di carica / presa 13 poli, camera 10	cable de carga / caja de anclufe a 13 polos, cámara 10	Laaddraad / stekkerdoos 13P kamer 10
	trailer / trailer recognition	remorque / détection de la fonction "remorque"	rimorchio / riconoscimento rimorchio	remolque / detección del remolque	Aanhanger / aanhangertentificatie
	Permanent current power supply	courant continue / alimentation électrique permanente	corrente / alimentazione continua	positivo continuo / alimentación de corriente permanente	Continuustroom / permanente stroomvoorziening
	Ground or Earth (31)	masse (31)	masa (31)	masa (31)	Massa (31)
	ground connection battery terminal lug	borne "moins" de la batterie	connessione negativa della batteria	conexión negativa de batería	Accupoolkleem aansluiting min
	positive connection battery terminal lug	borne "plus" de la batterie	connessione positiva della batteria	conexión positiva de batería	Accupoolkleem aansluiting plus
	fuse / fuse capacity 20 Ampère	ampérage 20 ampères	fusibile / fusibile con capacity 20 Ampère	fusible / amperaje 20 amperes	Zekering / zekeringsterkte 20 Ampère
	cigarette lighter / accessory socket	allume-cigare / prise d'accessoires	accendisigari / presa accessori	encendedor de cigarrillos / caja de accesorios	Sigarettenaansteker / accessoires stekkerdoos
	loudspeaker / buzzer	haut-parleur / vibreur	autoparlante / cicalino	altavoz / señal acustica de advertencia	Luidspreker / waarschuwingszoemer
	park distance control	assistance au parking	sensori di parcheggio	ayuda para aparcar	Inparkeerhulp
	switch / source of function	interrupteur / origine de fonction	interruttore / origine funzione	interruptor / origen de función	Schakelaar / functieoorsprong
	Connect together	raccorder	connessione	conectar	Koppelen
	disconnect	séparer	sconnessione	separar	Ontkoppelen
	Look at / see further information	considérer / voir informations ultérieures	considerare / vedere ulteriori informazioni	considerar / véase las informaciones	Let op / bekijk verdere informatie
	look carefully at selected area	faire attention à la zone sélectionnée	considerare area selezionata	considerar el área seleccionada	Let op gekozen bereik
	Present / Occupied / OK	disponible / occupé / OK	presente / occupato / OK	presente / ocupado / OK	Aanwezig / bezet / i.o.
	Not present / Not occupied / not OK	pas disponible / pas occupé / pas OK	non presente / non occupato / non OK	non presente / non ocupado / non OK	Niet aanwezig / niet bezet / niet i.o.
	left	gauche	sinistra	izquierdo	Links
	right	droite	destra	derecho	Rechts
	acoustic indication	signalisation acoustique	segnalazione acustica	señalización acústica	Akoestische signalering
	attention / important advice	attention / indication importante	attenzione / indicazione importante	atención / indicación importante	Attentie / belangrijke instructie